

digiTLine 3 1/8"

- Transmission line with flanges on both ends. Includes expansion connector, O-ring, and hardware kit.
- 90° reinforced elbow, equal leg. Includes one anchor connector, one O-ring and one hardware kit. Swivel flanges.
- 90° reinforced elbow, unequal leg. Includes one anchor connector, one O-ring, and one hardware kit. Swivel flanges.

Transmission Line

T/L Size	Catalog Number	Part Number	Impedance in Ohms	Leg Length 1	Leg Length 2	Approx. Wt. [kg]
3 1/8"	DL 35-004	R73590	50	N/A	N/A	56 lbs [25.4]

90° Elbow (Equal) Reinforced

T/L Size	Catalog Number	Part Number	Impedance in Ohms	Leg Length 1	Leg Length 2	Approx. Wt. [kg]
3 1/8"	DL 35-021	R74292	50	6"	N/A	13 lbs [5.9]

90° Elbow (Unequal) Reinforced

T/L Size	Catalog Number	Part Number	Impedance in Ohms	Leg Length 1	Leg Length 2	Approx. Wt. [kg]
3 1/8"	DL 37-022	R73593	50	6"	9"	10 lbs [4.54]

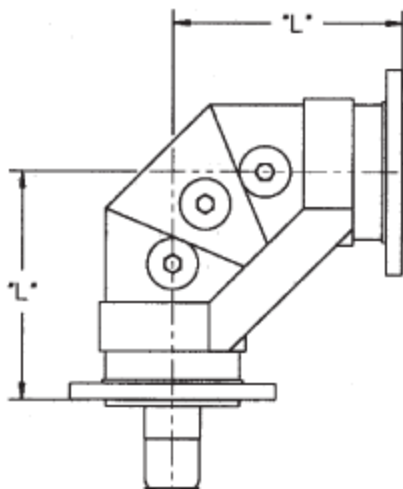

Equal Leg Elbow Joint

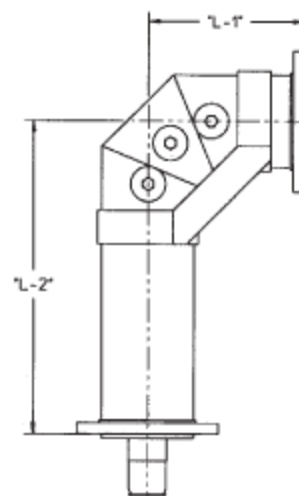

Unequal Leg Elbow Joint