



Dielectric[®]

**Radio Antennas &
Broadcast Components**

Trusted for Decades. Ready for Tomorrow.



TRUSTED FOR DECADES. READY FOR TOMORROW.

Since we helped pioneer broadcasting in 1942, Dielectric has been a leading innovator, with more than 200 patents in RF transmission technology, and continues to be the world's most trusted manufacturer and supplier of antennas and RF systems for TV and radio networks.

Dielectric blends decades of experience with a forward-looking embrace of software-defined planning and design. We employ many of today's brightest RF engineering minds, who are helping us drive innovation into the convergence of RF and IP technologies, beginning with our new RFHAWKEYE® monitoring system, which will change the way broadcasters monitor, manage and troubleshoot antenna and RF systems for generations to come.

Whatever new technologies emerge, there's a good chance they'll start here at Dielectric world headquarters in Maine, USA. We look forward to meeting your customized needs for the future.

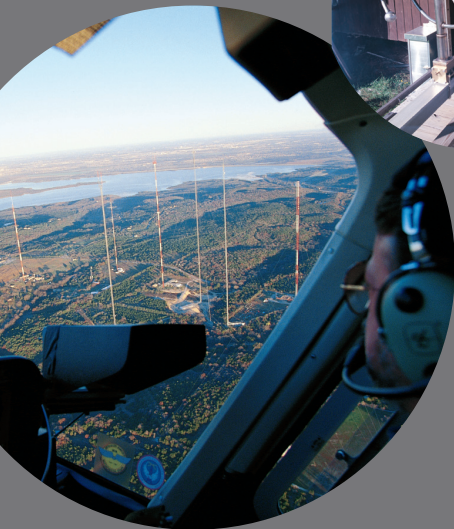

Products contained in this catalog may be covered by one or more of the following patents:

6,917,264; 6,887,093; 6,882,224; 6,870,443; 6,867,743; 6,816,040; 6,703,984; 6,703,911; 6,677,916; 6,650,300; 6,650,209; 6,617,940; 6,538,529; 6,373,444; 6,320,555; 5,999,145; 5,861,858; 5,455,548; 5,418,545; 5,401,173; 5,167,510; 4,988,961; 4,951,013; 4,899,165; 4,723,307; 4,654,962; 4,602,227; 7,084,822; 7,081,860; 7,061,441; 7,034,545; 7,012,574; 6,972,731; 6,972,648; 6,961,027; 6,914,579; 6,441,796; 7,102,589;

Additional patents are pending.

FM RESOURCES	2
HD RADIO™* ANTENNAS	3
HDR Series Interleaved Antenna	3
MULTI-STATION PANEL ANTENNAS	4
HDFMVee	4
HDFDM	6
HDCBR	8
FMVee	10
CBR	13
MULTI-STATION DCR ANTENNAS	15
DCR-U	15
DCR-S / HDR-S	16
DCR-MFE Funky Elbow	21
DCR-M / HDR-M	24
DCR-MT	29
DCR-C / HDR-C	30
DCR-H / HDR-H	35
BROADBAND SYSTEMS FOR MULTIPLEXING SIGNALS	40
DCR-S / DCR-M	40
FULL BAND MASTER OR AUXILIARY FM ANTENNAS	42
DCR-S / DCR-M	42
POWERLITE™ DCR-T FM ANTENNA	44
DCV ANTENNA	45
FM PYLON ANTENNA	46
PANEL ANTENNA	48
DCPJ	48
PATTERN STUDY & OPTIMIZATION	51
ELEVATION PATTERNS	53
RFR CONSIDERATIONS	54
MEDIUM & HIGH-POWER FM FILTERS	55
FM COMBINERS	62

Leading the Broadcast Industry Since 1942

Dielectric is the broadcast industry's leading supplier of over-the-air TV and radio systems worldwide. Dielectric's 80-year heritage speaks to its reputation for quality and innovation, with robust, problem-solving solutions built for longevity in the most demanding outdoor environments. Dielectric's product innovations address the entire RF infrastructure beyond the transmitter inside and outside the facility, with complete FM and HD Radio solutions that address today's requirements while anticipating what's next for the local broadcaster.

The company owns several patents for broadcast engineering breakthroughs, including the world's first FM radio manifold combiner. Dielectric also stands apart from competitors through its emphasis on customized support services, planning tools and monitoring solutions. Our customer-first philosophy and collaborative approach help radio broadcasters worldwide build and monitor their over-the-air systems with exacting precision.

Single Source of Responsibility

Our focus on the broader RF infrastructure means that your antennas, combiners, filters, elbows, switches and transmission line can all originate through Dielectric. This simplifies everything from site planning and initial ordering through delivery, repairs and troubleshooting. Emergency response is also made easier as multi-vendor systems often extend standard technical issues (such as system interoperability) and disaster recovery missions. Dielectric's renowned engineering quality and performance across all its product lines enables us to offer our customers the best warranty in the business.

Radio Innovation

Dielectric is the unquestioned market share leader for DTV antenna systems in North America, and leads the way in the CALA and APAC regions as DTV deployments accelerate. Our DTV expertise has now been applied to the unique needs of the FM broadcaster transitioning to digital radio. Dielectric's 80 years of FM antenna system design and manufacturing experience has birthed unique innovations for HD Radio broadcasters worldwide, including digital and hybrid antennas, filters and combiners – as well as complete systems for today's needs, including remote monitoring.

Premium Broadcast Quality

Dielectric's unique RF product range outpaces the competition when it comes to user benefits. Our combiner systems offer better frequency response, lower insertion loss and lower group delay variation than competitive products. This means clearer FM signals today and enhanced digital radio capabilities later, plus improved broadcast quality overall. Dielectric also manufactures advanced antennas with variable bay spacing to ensure better control of elevation and azimuth patterns.



HDR SERIES INTERLEAVED FM ARRAY

- Interleaved analog/HD Radio array for simultaneous transmission of both signals
- Efficient—no additional analog or digital system losses requiring higher TPO
- Ability to interleave within existing antenna
- High isolation requiring minimal supplemental filtering
- Transmitter operating cost reduced through efficient design
- Consistent azimuth and elevation patterns for both analog and digital
- Separate inputs allow redundancy for emergency operations
- Flexibility in radiator type and feed system design
- Common aperture — only 5'-7' (1.52 - 2.13m) of additional tower space required
- Designed for -10 dB IBOC signals
- Uses 33% less energy than common amplification
- >40 dB isolation

When considering cost, efficiency, coverage and tower space availability, many FM broadcasters will choose to interleave their digital antenna with either a new or existing analog antenna. Dielectric HDR Series antenna solutions provide extensive flexibility while maintaining high isolation between the digital and analog systems.

Two complete circularly polarized antenna arrays are interleaved at half wavelength intervals on a supporting structure. Each antenna array is typically composed of the same number of elements and is fed by a separate transmission line connected to the appropriate transmitter. By interleaving the digital left hand-polarized bays with the analog right hand polarized bays, coupling between the antenna systems is greatly reduced. No circulator is required, reducing systems complexity and expense for the broadcaster.

Since both antennas will have the same tower geometry adjacent to them, the azimuth and elevation patterns of both systems will be the same. This ensures that the system meets FCC and predicted pattern requirements.

HDR Series arrays are very cost-effective. The cost of the antenna, second run of low power transmission line and low power circulator is substantially less than the system cost of a 10 dB coupler and a transmitter large enough to compensate for additional system losses. Also, the associated operating costs are substantially reduced (as much as 10% for analog and as much as 90% for digital) due to the efficiency of the HDR Series array.

The HDR Series antenna is available in HDR-H, HDR-C and HDR-M versions depending on specific requirements. The Dielectric concept is flexible. Interleaving can be applied to any of Dielectric's side mounted circularly polarized antenna elements combined with any mixture of feed designs.

¹Patents: 6,972,731; 6,914,579; 7,102,589



HDFMVEE

- Full 20 MHz bandwidth
- Power ratings up to 10 class C stations
- Stainless steel element for excellent reliability
- Designed for -10 dB IBOC signals
- Antenna isolation >40 dB for analog and IBOC
- Single or dual EIA inputs
- Element radome standard
- Low downward radiation
- Omni-directional free space pattern performance
- Ideal for space combining analog and digital signals
- -40 dB isolation

The HDFMVee antenna offers FM stations the advantages of top-mounting and combined station operation. It's designed for digital, analog, or both types of service. When operating in dual mode (IBOC/analog), it offers space combining with superior antenna isolation.

Multi-station FM operation—where two or more stations share the same antenna—has increased in popularity due to the inherent cost savings. The wide bandwidth characteristics of the HDFMVee antenna make possible multi-station operation with excellent pattern circularity, through the use of broadband radiating elements in conjunction with high-power element hybrids.

The unique design of the HDFMVee antenna offers precise control of the elevation pattern, which is critical in mobile receiver reception. Beam tilt and null fill may be provided by means of standard phase and power distribution techniques.

The HDFMVee antenna is designed for high-power operation, enabling station flexibility in transmission system design. Our conservative power rating ensures adequate design headroom for long-term reliability. The Dielectric HDFMVee antenna can be configured with one or two input ports for analog and digital. This feature allows the top and bottom four bays of a typical eight-bay antenna to be fed by two independent transmission lines. Should standby operation be necessary, one half of the eight-bay antenna may be used at reduced power.

The Dielectric HDFMVee antenna will meet the specific requirements of FM broadcasters worldwide. Your Dielectric representative can provide you with additional information for your review and consideration.

Measured Relative Field

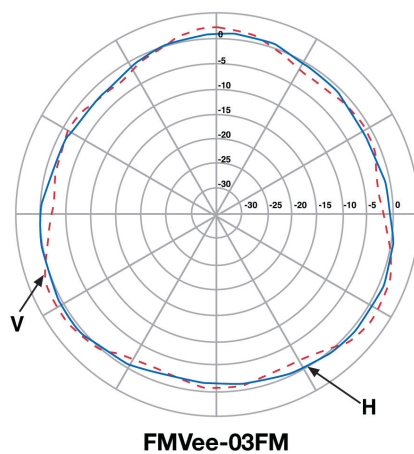

CALCULATED ELEVATION PATTERN

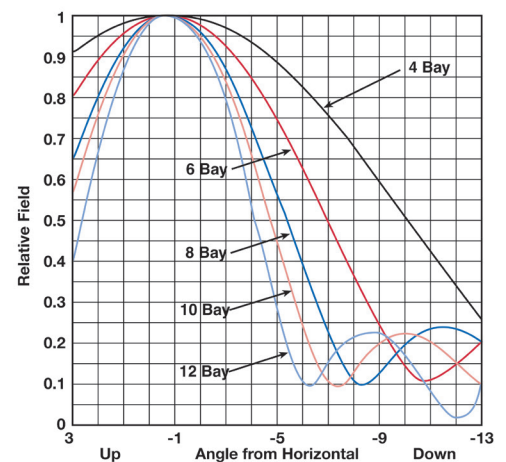

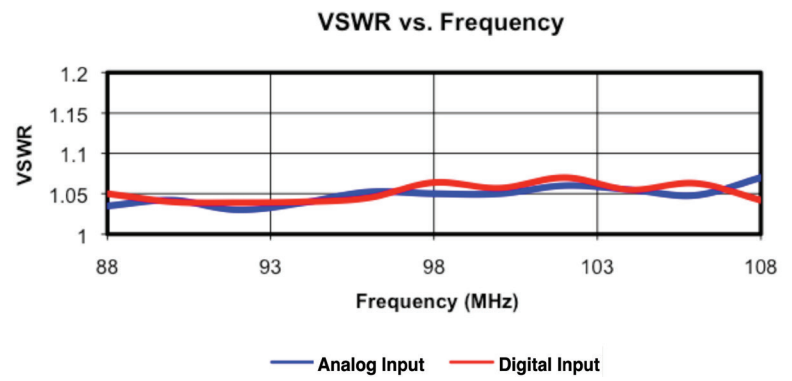
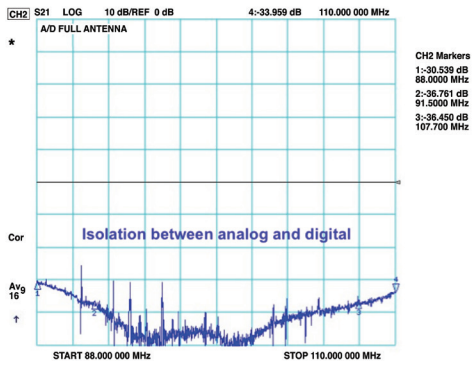

Mechanical Specifications

Antenna Type	# of Bays	Weight lbs (kg)	Windload lbs (kg)	Projected Area ft ² (m ²)
HDFMvee-O3-2FM/6U-1	2	6,500 (2,958)	4,600 (2,093)	92 (8.5)
HDFMvee-O3-4FM/12U-1	4	12,500 (5,688)	9,200 (4,186)	184 (17.1)
HDFMvee-O3-6FM/18U-1	6	19,000 (8,645)	13,800 (6,279)	276 (25.6)
HDFMvee-O3-8FM/24U-1	8	26,000 (11,830)	18,400 (8,372)	368 (34.2)
HDFMvee-O3-10FM/30U-1	10		Contact Factory	
HDFMvee-O3-12FM/36U-1	12		Contact Factory	

Notes:

1. FMvee antennas must be pressurized with dry air or nitrogen.
2. Loads provided assume 50/33 PSF, no ice.
3. Length includes standard 4 ft. (1.22 m) lightning rods.
4. Windloads will vary depending on design wind speed and conditions at installation location.
5. Area calculated expressed in terms of equivalent flats (RS-222-C standard).
6. Windload force calculated based on 50 pounds per square foot (50 PSF) on flats (RS-222-C standard).
7. To convert area to equivalent rounds, multiply area by 1.5.
8. To convert area to Aerodynamic area (CaAa - linear or CaAc - discrete) based on EIA-222-F standard, multiply area by 1.8.

Electrical Specifications

Antenna Type	# of Bays	Gain Polarization ¹		Power Rating kW ³
		Power Gain	dB	
HDFMvee-O3-2FM/6U-1	2	0.90	-0.46	125
HDFMvee-O3-4FM/12U-1	4	1.80	2.56	135
HDFMvee-O3-6FM/18U-1	6	2.70	4.31	185
HDFMvee-O3-8FM/24U-1	8	3.70	5.68	185
HDFMvee-O3-10FM/30U-1	10	4.60	6.63	185
HDFMvee-O3-12FM/36U-1	12	5.60	7.48	250

Notes:

1. RMS gain data is given relative to dipole. Values given are for each polarization and nominal for mid band and include standard harness configurations. Gain will vary depending on feed system, frequency, null fill and beam tilt.
2. Null fill 10% is standard for 4 bays or greater. Beam tilt .75 degrees assumed. Other values of tilt and fill are available upon request.
3. Power ratings are nominal @ 104°F (40°C) and assume pressurization with dry air or nitrogen to 5 psi minimum. Power ratings may vary dependent on specific feed system design, and local conditions.
4. Higher power ratings and dual inputs are available on request.
5. Antenna components and feed harnesses are optimized for FM channels of interest.
6. Typical circularity ±1.5 dB



HDFDM

- Very low aerodynamic area
- Ideal for candelabra applications
- High-power ratings
- In dual mode, IBOC injected by high level combining or common amplification
- Galvanized steel, brass and copper construction for excellent reliability
- Low downward radiation
- Near perfect omni-directional pattern performance
- 10 MHz bandwidth
- Designed for -10 dB IBOC signals

The HDFDM is legendary for its reliability and proven performance. The HDFDM antenna offers ideal characteristics for FM stations desiring the advantages of top mounting and combined station operation and is designed for digital, analog, or both types of service.

The Dielectric HDFDM radiator consists of a patented truncated helix dipole radiator fed in phase and mounted three around on a structural pole mast. The vertical stubs on each element cancel the effect of the vertical pole support structure and help shape the element patterns for a near perfect omnidirectional azimuth pattern. Each layer of dipoles is specifically tuned and patterns are optimized in conjunction with the supporting pole.

The HDFDM dipole element is supported off a mounting pole, which also serves as a mounting for the balun assembly. This results in an aerodynamic design that significantly reduces weight and windload requirements of the supporting structure. This often represents substantial savings in support structure cost compared with panel style designs. The HDFDM also has very low radar cross-sectional area, which makes it the antenna of choice for candelabra installations because it has a minimal effect on other antennas mounted on adjacent corners of the tower at the same height.

Multi-station FM operation where two or more stations share the same antenna has increased in popularity due to the inherent cost savings that can be realized. Multi-station operation with excellent pattern circularity can be achieved with the wide bandwidth characteristics the HDFDM antenna offers. These characteristics are achieved through the use of broadband radiating elements. The HDFDM is recommended for applications of up to 10 MHz in bandwidth. For greater bandwidth requirements refer to Dielectric's HDFMvee and HDCBR antennas or consult Dielectric with your specific needs.

For omnidirectional operation, the shape of the HDFDM's azimuth pattern will vary from omni by as little as +/-1.5 dB for top mount configurations, putting it a step ahead of panel type antennas. The unique design of the HDFDM antenna offers precise control of the elevation pattern, which is critical in mobile receiver reception. Beam tilt and null fill may be provided by means of standard phase and power distribution techniques. Consult Dielectric for specific applications.

The HDFDM antenna is designed for high-power operation enabling station flexibility in transmission system design. Our conservative power rating ensures adequate design headroom for long-term reliability. The Dielectric HDFDM antenna can be configured with one or two input ports. This feature allows the top and bottom portions of a typical five- or seven-bay antenna to be fed by two independent transmission lines. Should standby operation be necessary, one half of the antenna may be used at reduced power.

FM panel antennas are generally utilized in a number of specific situations:

- To achieve better azimuth patterns on larger towers than typical side-mounted element arrays can provide.
- High-power and/or very directional applications
- Multi-station or shared facilities.

All antennas are designed specific to the particular needs of the station(s) and to tower limitations. Dielectric will assist the station or consultant in choosing the proper design and configuration to achieve project goals.

All panel antennas contain elements that are DC grounded for lightning protection.

Mechanical Specifications

Antenna Type	# of Bays	Weight lbs (kg)	Windload lbs (kg)	Projected Area ft ² (m ²)
HDFDM-5A	5	6,200 (2,812)	3,000 (1,360)	60 (5.57)
HDFDM-7A	7	11,400 (5,171)	4,150 (1,882)	83 (7.71)

Notes:

1. RMS gain data is given relative to dipole. Values given are for each polarization and nominal for mid band and include standard harness configurations. Gain will vary depending on feed system, frequency, null fill and beam tilt.
2. Null fill is standard for 5 bays or greater.
3. Power ratings are nominal @40°C (104°F) ambient and assume pressurization with dry air or nitrogen to 5 psi minimum. Power ratings may vary dependent on specific feed system design, and local conditions.
4. Higher power ratings and dual inputs are available on request.
5. Antenna components and feed harnesses are optimized for FM channels of interest.
6. Area calculated expressed in terms of equivalent flats (RS-222-C standard).
7. Windload force calculated based on 50 pounds per square foot (50psf) on flats (RS-222-C standard).
8. To convert area to equivalent rounds, multiply area by 1.5.
9. To convert area to Aerodynamic area (CaAa - linear or CaAc - discrete) based on EIA-222-F standard, multiply area by 1.8.

*Other gain values are available. Please contact factory.

Electrical Specifications

Antenna Type	Gain Polarization Spacing ¹		Power Rating kW ³
	Power Gain*	dB	
HDFDM-5A	2.20	3.42	70
HDFDM-7A	3.00	4.77	70

Notes:

Please contact a Dielectric representative for high-power ratings.

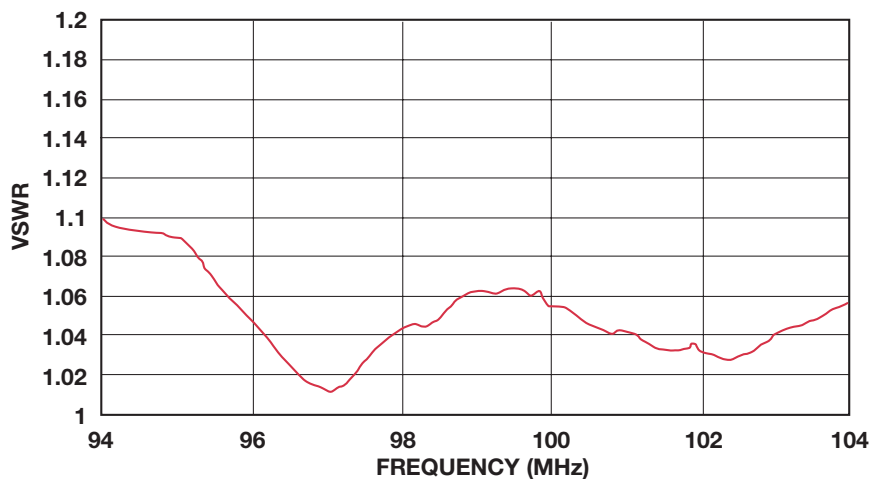



HDCBR

- Ideal for multi-station operation
- Full 20 MHz bandwidth
- High-power handling
- Very low VSWR
- Single or dual EIA inputs
- Designed for -10 dB IBOC signals
- Minimal windloading
- Superb azimuth circularity and elevation pattern control to ensure uniform coverage
- Custom azimuth patterns available
- Superior antenna isolation
- Ideal for space combining analog and IBOC signals
- >40 dB isolation

The HDCBR (Cavity Backed Radiator) antenna offers ideal characteristics for FM stations desiring the advantages of combined station operation or to stations requiring special directional coverage. The antenna is designed for digital, analog, or both types of service.

The Dielectric HDCBR consists of a crossed dipole radiator fed in phase quadrature and mounted within a square cavity. Rotating RF energy is produced when the cavity is excited by the dipole elements. Cavity size is principally determined by beamwidth requirements. A beamwidth of 90 degrees is required for a 4-around array and 120 degrees is required for a 3-around array (measured at the half-voltage coordinates).

Dielectric Advantages

The cavity used in the Dielectric circularly polarized FM antenna is a welded steel galvanized grid. The cavity grid is supported from a center mounting plate, which also serves as a mounting for the dipole assembly and for attachment of the unit to the supporting structure. The use of grid cavities and aerodynamic design significantly reduces weight and windload requirements of the supporting structure. This often represents substantial savings in support structure cost compared with other panel style antenna designs.

For omnidirectional operation, the shape of the standard azimuth pattern will vary from omni by less than ± 2.0 dB for optimized tower configurations. Stations employing directional arrays will find one of the several patterns available to be ideally suited to their specific needs.

The Dielectric HDCBR antenna is designed for high-power operation enabling station flexibility in transmission system design. Our conservative power rating ensures adequate design headroom for long term reliability. The Dielectric HDCBR antenna can be configured with one or two input ports. This feature allows the top and bottom portions of a typical antenna to be fed by two independent transmission lines. Should standby operation be necessary, one half of the system may be used at reduced power.

Multi-Station Operation

Multi-station FM operation where two or more stations share the same antenna has increased in popularity due to the inherent cost savings which can be realized. Multi-station operation can be achieved only with the wide bandwidth characteristics the Dielectric CBR antenna offers.

These characteristics are achieved through the use of a broadband radiating element in conjunction with high-power hybrid junctions.

Dielectric also offers the associated combining equipment necessary for multi-station

operation. Dielectric's experience with multiplexer installations ensures proper combiner operation to optimize the system operation.

Azimuth Circularity

For omnidirectional operation, the shape of the standard azimuth pattern will vary from omni by less than ± 2.0 dB for three-sided tower configurations. With a four-around antenna array, the typical circularity will be comparable.

Stations employing directional arrays will find one of the several patterns available to be ideally suited to their specific needs.

High-Power Capabilities

The Dielectric CBR antenna is designed for high-power operation enabling station flexibility in transmission system design. Our conservative power rating ensures adequate design headroom for long term reliability.

The Dielectric CBR antenna can be configured with one or two input ports. This feature allows the top and bottom six bays of a typical twelve-bay antenna to be fed by two independent transmission lines. Should standby operation be necessary, one half of the system may be used at reduced power.

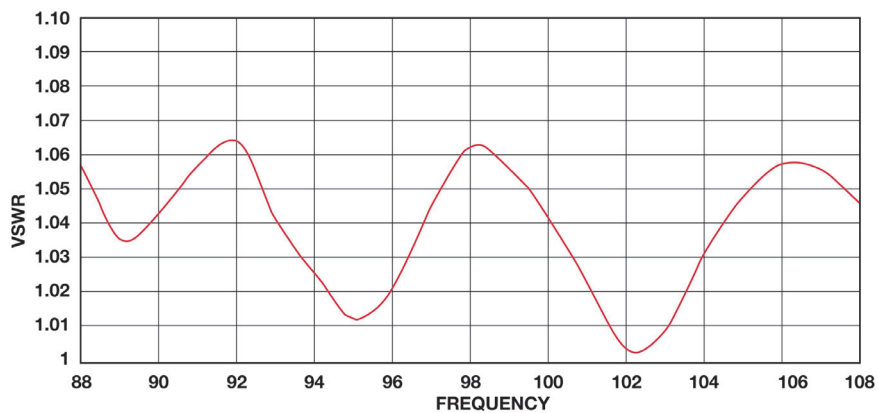

RIGHT HAND CP

LEFT HAND CP

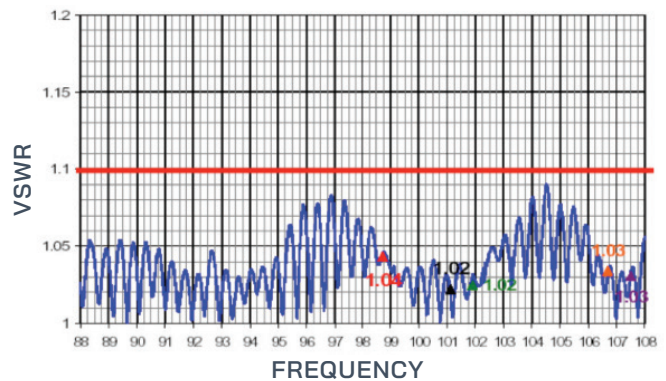
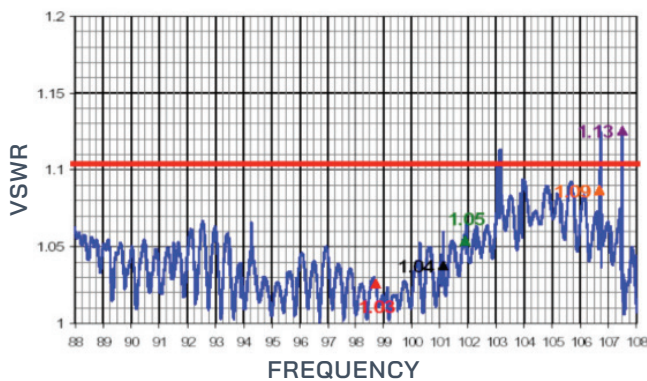

Typical VSWR responses including 1100' of transmission line



FMVee

- Full 20 MHz bandwidth
- Power ratings up to 10 class C stations
- Stainless steel element for excellent reliability
- Designed for -10 dB IBOC signals
- Single or dual EIA inputs
- ABS feed point radome standard
- Low downward radiation
- Near omni-directional pattern performance
- RH circular polarization standard
- Low windload, flanged, top mount design
- Lightning resistant – grounded radiating elements
- Ideal for common amplification or high level combining

The FMVee (arrowhead dipole) antenna offers ideal characteristics for FM stations desiring the advantages of top mounting and combined station operation.

The Dielectric FMVee radiator consists of a crossed dipole radiator fed in phase quadrature and mounted three around on a structural pipe mast. Rotating RF energy is produced when the element is fed in phase quadrature by an integral element hybrid divider. The wings between each element shape the element patterns and also help isolate adjacent elements.

The element used in the Dielectric FMVee circularly polarized antenna is a welded stainless steel grid. The element is supported off a mounting pole, which also serves as a mounting for the balun assembly. The aerodynamic elements and screens significantly reduce weight and windload requirements of the supporting structure. This often represents substantial savings in support structure cost compared with panel style designs.

Multi-station FM operation where two or more stations share the same antenna has increased in popularity due to the inherent cost savings that can be realized. Multi-station operation with excellent pattern circularity can be achieved with the wide bandwidth characteristics the FMVee antenna offers. These characteristics are achieved through the use of broadband radiating elements in conjunction with high-power element hybrids.

Dielectric also offers the associated combining equipment necessary for multi-station operation. Dielectric's experience with multiplexer installations ensures proper combiner operation to optimize the system performance.

For omnidirectional operation, the shape of the standard azimuth pattern will vary from omni by less than +/-2 dB for top mount configurations.

The unique design of the FMVee antenna offers precise control of the elevation pattern, which is critical in auto receiver reception. Vertical pattern contouring to introduce beam tilt and null fill may be provided by means of standard phase and power distribution techniques.

The FMVee antenna is designed for high-power operation enabling station flexibility in transmission system design. Our conservative power rating ensures adequate design headroom for long-term reliability. The Dielectric FMVee antenna can be configured with one or two input ports. This feature allows the top and bottom four bays of a typical eight-bay antenna to be fed by two independent transmission lines. Should standby operation be necessary, one half of the eight-bay antenna may be used at reduced power.

Mechanical Specifications

Model	Length ft (m)	CfAc ft ²	Ma ft (m)	Weight lbs (kg)
FMVee-O3-2FM/6U-1	21.66 (6.49)	92	8.83 (2.65)	6,500 (2,925)
FMVee-O3-4FM/12U-1	39.00 (11.70)	184	17.50 (5.25)	12,500 (5,625)
FMVee -O3-6FM/18U-1	56.33 (16.90)	276	26.16 (7.85)	19,000 (8,550)
FMVee O3-8FM/24U-1	73.66 (22.09)	368	34.83 (10.45)	26,000 (11,700)
FMVee -O3-10FM/30U-1	Contact Factory			
FMVee -O3-12FM/36U-1	Contact Factory			

Notes:

1. FMVee antennas must be pressurized with dry air or nitrogen.
2. Loads provided assume TIA/EIA-222-F, 80 mph basic wind speed, 1,200 ft (360 m) tower, 42.6 psf. No ice.
3. Length includes standard 4 ft (1.2m) lightning rods.
4. Windloads will vary depending on design wind speed & conditions at installation location.

Electrical Specifications

Model	# of Bays	RMS Gain Ea. Pol. (ratio)	RMS Gain Ea. Pol. (ratio)	Input	Max. Avg. Power (kW)	Max. Peak Windload (kW)	Rad. Center Above Tower Top ft (m)
FMVee-O3-2FM/6U-1	2	.90	-.46	6-50	125	2700	8.83 (2.65)
FMVee-O3-4FM/12U-1	4	1.8	2.56	6-50	135	3300	17.50 (5.25)
FMVee -O3-6FM/18U-1	6	2.7	4.31	6-50 EHT	185	3900	26.16 (7.84)
FMVee O3-8FM/24U-1	8	3.7	5.68	6-50 EHT	185	3900	34.83 (10.45)
FMVee -O3-10FM/30U-1	10	4.6	6.63	6-50 EHT	185	3900	43.50 (13.05)
FMVee -O3-12FM/36U-1	12	5.6	7.48	6-50 EHT Dual	250	6000	52.16 (15.64)

Notes:

1. RMS gain data is given relative to dipole. Values given are for each polarization, nominal for mid band and include standard harness configurations. Gain will vary depending on feed system, frequency, null fill and beam tilt.
2. Null fill 10% is standard for 4 bays or greater. Beam tilt .75 degrees assumed. Other values of tilt and fill are available upon request.
3. Power ratings are nominal @ 40°C (104°F) and assume pressurization with dry air or nitrogen to 5 psi minimum. Power ratings may vary dependent on specific feed system design, and local conditions.
4. Higher power ratings and dual inputs are available on request.
5. Antenna components and feed harnesses are optimized for FM channels of interest.

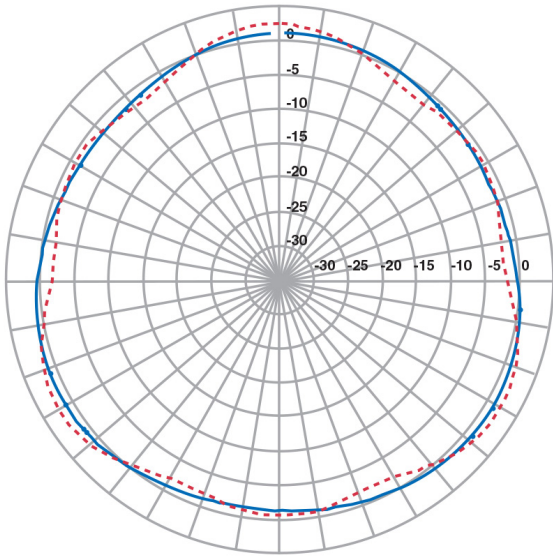

CALCULATED ELEVATION PATTERN

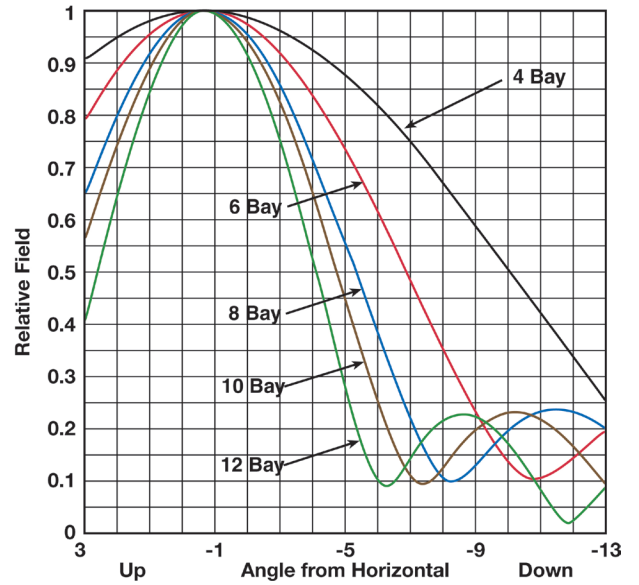

VSWR VS. FREQUENCY

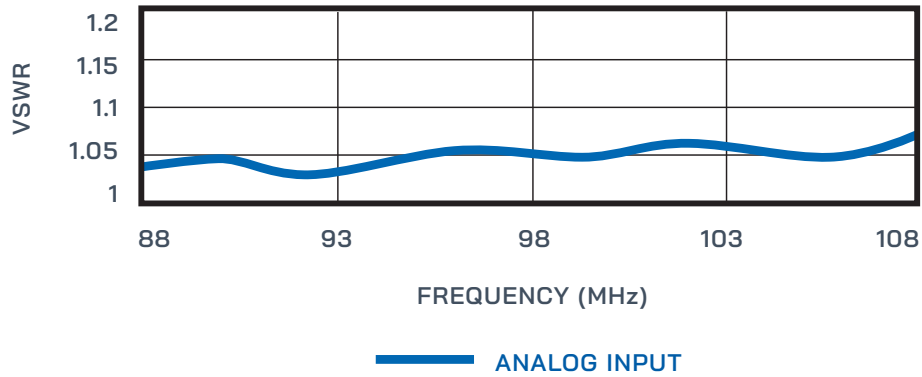



CBR

- Ideal for multi-station operation
- Designed for common amplification or high level combining
- High-power handling
- Very low VSWR
- Minimal windloading
- Superb horizontal circularity and vertical pattern control to ensure uniform coverage
- Available in one, two, three or four around configurations
- Full assembly and testing available at our full capability antenna test range to ensure top performance.
- Designed for -10 dB IBOC signals
- >40 dB isolation

The CBR (Cavity Backed Radiator) antenna offers ideal characteristics for FM stations desiring the advantages of combined station operation or to stations requiring special directional coverage.

The Dielectric Cavity Backed Radiator consists of a crossed dipole radiator fed in phase quadrature and mounted within a circular cavity. Rotating RF energy is produced when the cavity is excited by the dipole elements. The signal emanating from the cavity is right-hand circular. The field rotates clockwise as viewed in the direction of propagation. Cavity size is principally determined by beamwidth requirements. A beamwidth of 90 degrees is required for a 4-around array and 120 degrees is required for a 3-around array (measured at the half-voltage coordinates). When operating in dual mode (IBOC/analog) this antenna is designed for common amplification or high level combining.

Grid Cavity

The cavity used in the Dielectric circularly polarized FM antenna is a welded steel galvanized grid. The cavity grid is supported from a center mounting plate, which also serves as a mounting for the dipole assembly and for attachment of the unit to the supporting structure. The use of grid cavities and aerodynamic design significantly reduces weight and windload requirements of the supporting structure. This often represents substantial savings in support structure cost compared with other panel style antenna designs.

Multi-Station Operation

Multi-station FM operation where two or more stations share the same antenna has increased in popularity due to the inherent cost savings which can be realized. Multi-station operation can be achieved only with the wide bandwidth characteristics the Dielectric CBR antenna offers.

These characteristics are achieved through the use of a broadband radiating element in conjunction with high-power hybrid junctions.

Dielectric also offers the associated combining equipment necessary for multi-station operation. Dielectric's experience with multiplexer installations ensures proper combiner operation to optimize the system operation.

Azimuth Circularity

For omnidirectional operation, the shape of the standard azimuth pattern will vary from omni by less than ± 2.0 dB for three-sided tower configurations. With a four-around antenna array, the typical circularity will be comparable.

Stations employing directional arrays will find one of the several patterns available to be ideally suited to their specific needs.

Elevation Pattern

The unique design of the CBR antenna offers precise control of the elevation pattern which is critical in auto receiver reception. Vertical pattern contouring to introduce beam tilt and null fill may be provided by means of standard phase and power distribution techniques.

High-Power Capabilities

The Dielectric CBR antenna is designed for high-power operation enabling station flexibility in transmission system design. Our conservative power rating ensures adequate design headroom for long term reliability.

The Dielectric CBR antenna can be configured with one or two input ports. This feature allows the top and bottom six bays of a typical twelve-bay antenna to be fed by two independent transmission lines. Should standby operation be necessary, one half of the system may be used at reduced power.

Full Range Testing

The Dielectric antenna test range is one of the few facilities in existence capable of complete antenna testing. Two test transmitters are located adjacent to the range. This unique geographical setting offers ideal conditions for testing approaching the "free space" situation of an installed antenna.

Here the computer-plotted azimuth and elevation patterns of a Dielectric antenna can be proven out with highly accurate and sophisticated test equipment – translating the theory of calculated patterns into the reality of actual antenna performance.

Meeting Precise Requirements

The Dielectric CBR antenna can meet the exacting requirements of FM broadcasters. Your Dielectric representative can provide you with additional information for your review and consideration.

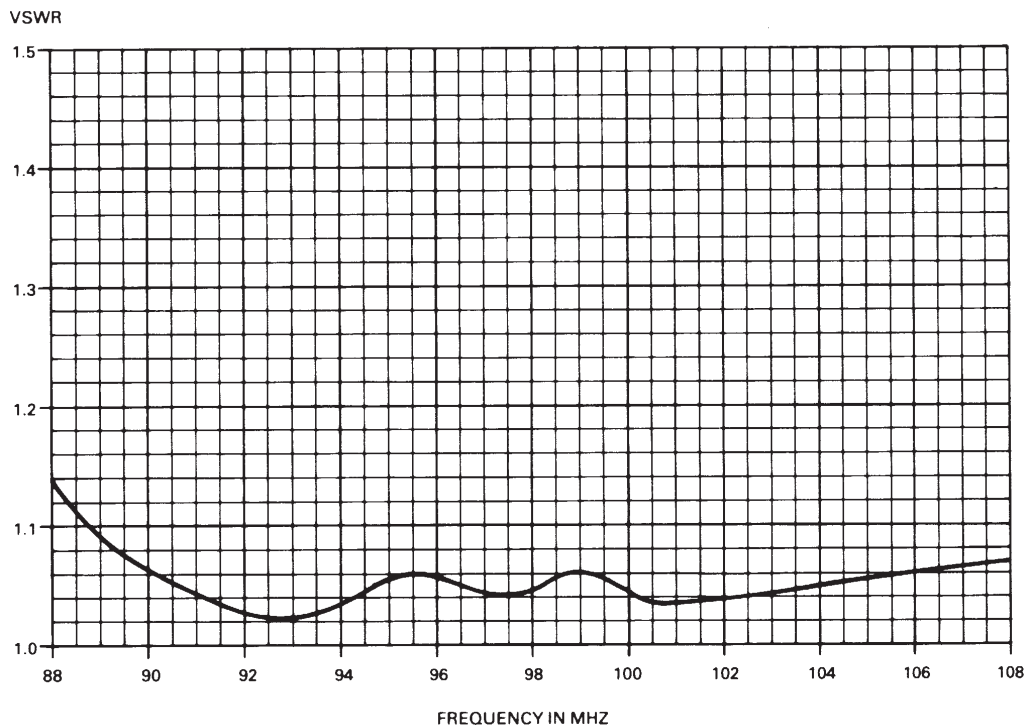

Measured VSWR Characteristics of Multiplexed CBR at antenna input port



DCR-U CIRCULARLY POLARIZED FM ANTENNA

- High-power/peak voltage rating
- Power rating of 40kW for single bay
- Broadband for multi-station operation
- Stainless steel elements
- Radomes or integral deicers optional
- Excellent circularity <+/- 1 dB for both horizontal and vertical polarization

The DCR-U features a pressurized tap point and 4" balun which makes it specially designed to handle the high-powers and voltages associated with combined multi-station operation. The broadband quadrupole design provides excellent circularity for both the horizontal and vertical polarizations while maintaining an equal H/V ratio, important for today's mobile reception. The "U" series antenna has a power rating of 40kW per bay and is available in arrays up to 12 bays.

	# of Bays	Without Radomes				With Radomes				db
		Weight (lbs)		EPA (ft ²)		Weight (lbs)		EPA (ft ²)		
		λ Spaced	$\frac{1}{2} \lambda$ Spaced	λ Spaced	$\frac{1}{2} \lambda$ Spaced	λ Spaced	$\frac{1}{2} \lambda$ Spaced	λ Spaced	$\frac{1}{2} \lambda$ Spaced	
DCR-U1	1	190		6.4		253		9.1		
DCR-U2	2	341	313	12.1	10.7	468	440	17.7	16.2	
DCR-U3	3	492	437	17.9	14.9	682	627	26.2	23.3	-0.16
DCR-U4	4	643	560	23.6	19.2	897	814	34.8	30.4	
DCR-U5	5	794	684	29.4	23.5	1111	1001	43.3	37.5	
DCR-U6	6	946	808	35.1	27.8	1326	1188	51.8	44.5	2.45
DCR-U7	7	1097	931	40.9	32.1	1541	1375	60.4	51.8	
DCR-U8	8	1248	1055	46.6	36.4	1755	1562	68.9	58.7	
DCR-U10	10	1550	1302	58.2	45	2184	1936	86	72.8	
DCR-U12	12	1853	1549	69.7	53.6	2614	2310	103.1	87	5.27

Loads per ANSI/TIA 222G, reference frequency 98Mhz, end fed antenna

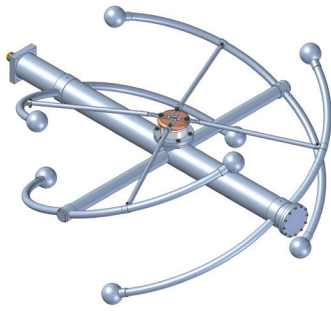

DCR-S/HDR-S

- DCR-M: Right Hand Circularly Polarized
- HDR-M: Left Hand Circularly Polarized
- DCR-M/HDR-M IBOC compatible
- Interleaved provides -40dB of isolation
- Stainless steel elements
- Ideal for Class B and C stations
- 28 kW for a single bay
- Fine matcher included
- Radomes or integral deicers optional
- VSWR field adjustable
- High-power bays for multiplexing high-power signals
- High peak power ratings

The DCR-S/HDR-S has been used extensively for high-power broadband applications. The “S” series antennas are circularly polarized with a power rating of 28 kW for a single bay and are available in stacked arrays of up to 16 bays with an input rating to 120 kW. For situations where ice formation is common, the arrays can be equipped with optional electrical deicers or radomes. The antenna is DC grounded and does not require shorting stubs. Each array is supplied with an input fine matcher for field optimization. For reduced downward radiation, the use of a custom feed design allows for shorter spacings in a series fed configuration.

High-Power Input Capability

The DCR-S and HDR-S were designed to handle high input power ideally suited for multiplexing. The “S” series antenna is available with optional 4 1/16” feed system having a power input rating (for five or more bays) of 70 kW. Arrays with 6 1/8” inputs are also available.

Multi-Station Operation

The wide bandwidth and the high-power input capability of the “S” series antenna permits optional multi-station operation.

Beam Tilt & Null Fill

Beam tilt and/or null fill are available options. These options are ordinarily specified for arrays of 8 bays or more. Even numbered arrays of six sections and fewer may include one or both options and typically are designed as a center-fed array. The “S” series antenna is available in directional arrays which are custom-built to the needs of the station.

Quadrapole Design

The four-dipole-per-element design offers the advantage of more symmetrical azimuth pattern performance and H/V ratio than dual dipole designs, providing more robust coverage. Low downward radiation options available—contact factory.

General Specifications

Polarization	Pattern Circulatory in Free Space	VSWR (max) at Input w/o field trim	VSWR (max) at Input w/ field trim, Top or Side Mounted	Input	Bay Dimensions (w/o Radome)	Bay Dimensions (w/ Radome)
Circular	± 1 dB	Top Mounted 1.2:1	(+/-200 KHz): 1.05:1	3 1/8" EIA	Diameter 36" (915 mm)	Diameter 44" (1,118 mm)
		Side Mounted 1.5:1	(+/-400 KHz): 1.10:1		Height 29" (737 mm)	Height 34" (864 mm)

Mounting Dimensions

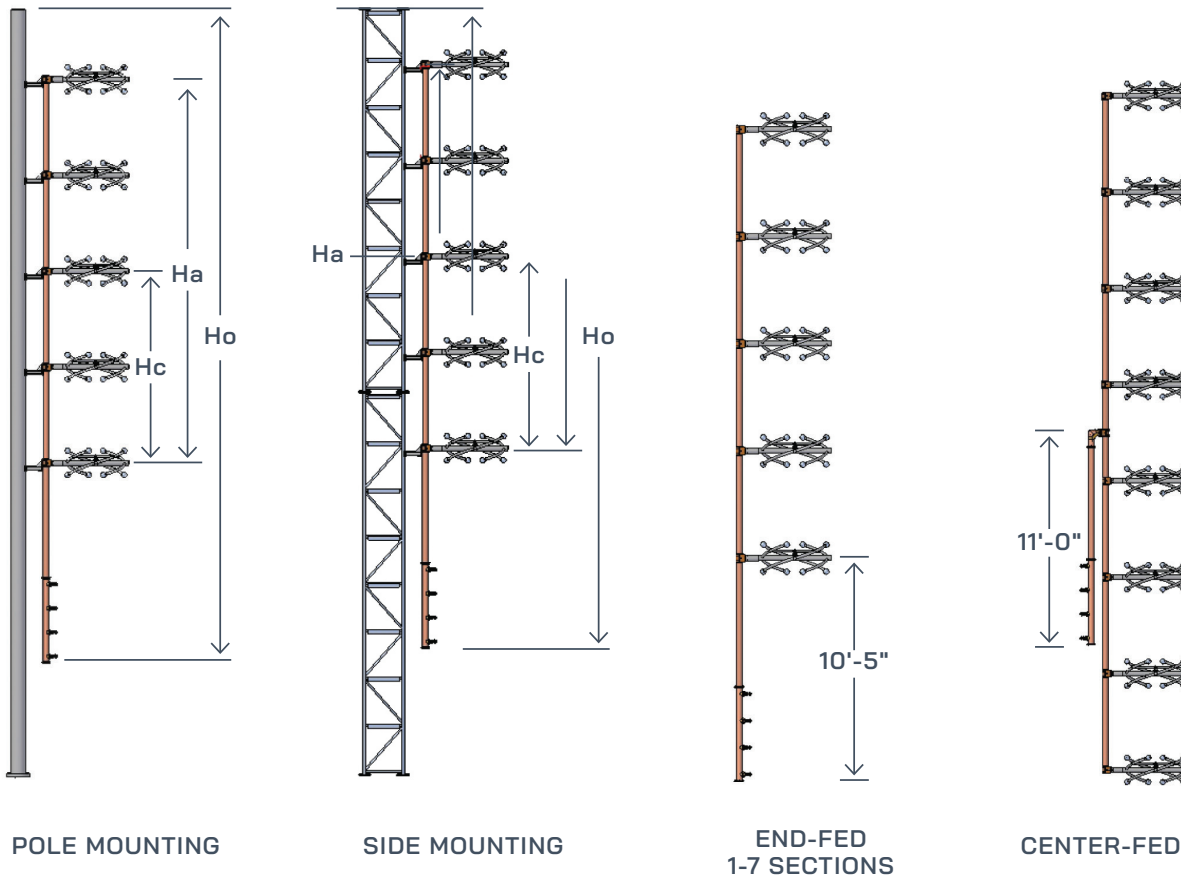

H_a = Antenna aperture length
 H_c = Antenna center of radiation
 H_o = Antenna overall length needed for mounting
 $H_a = 984/f \times [s(x-1)]$
 $H_c = H_a/2$
 $H_o \text{ end-fed} = H_a + 5' \text{ top} + 10' - 5" \text{ bottom}$
 $H_o \text{ center-fed} = H_a + 5' \text{ top} + 5' \text{ bottom}$

All dimensions in feet
 f = frequency in megahertz (MHz)
 s = bay spacing in fraction of wavelengths
 example: $\frac{1}{2}$ wavelength = .5
 x = number of antenna bays

Note: Antennas ordered w/beam tilt and/or null fill are supplied with center feed and require even number of bays.

Deicer Specifications:
 Power (nominal per bay): 1200 W
 Voltage: may be wired for 208 V or 240 V service, single or three phase.

Optional

Ice sensor and deicer controller.

Mechanical Specifications

Antenna Type DCR-S or HDR-S	# of Bays	Without Radomes			
		Weight lbs (kg)		CaAc ft ² (m ³)	
		λ Spaced	1/2 λ Spaced	λ Spaced	1/2 λ Spaced
DCR-S1 HDR-S1	1	198 (90)	—	7.2 (.7)	—
DCR-S2 HDR-S2	2	322 (146)	307 (139)	14.1 (1.3)	12.6 (1.2)
DCR-S3 HDR-S3	3	451 (205)	421 (191)	21 (2.0)	18 (1.7)
DCR-S4 HDR-S4	4	581 (264)	536 (243)	27.9 (2.6)	23.4 (2.2)
DCR-S5 HDR-S5	5	710 (322)	650 (295)	34.8 (3.2)	28.8 (2.7)
DCR-S6 HDR-S6	6	840 (381)	765 (347)	41.7 (3.9)	34.2 (3.2)
DCR-S7 HDR-S7	7	969 (440)	879 (399)	48.5 (4.5)	39.5 (3.7)
DCR-S8 HDR-S8	8	1142 (518)	1037 (470)	55.7 (5.2)	45.2 (4.2)
DCR-S10 HDR-S10	10	1401 (635)	1266 (574)	69.5 (6.5)	56 (5.2)
DCR-S12 HDR-S12	12	1660 (753)	1495 (678)	83.3 (7.7)	66.8 (6.2)

Notes:

1. CaAc and weight includes bays and standard extension brackets for mounting. Excludes custom mounts. For antennas that include pattern studies, contact factory for additional information.
2. Dimensions are for antennas at 98.0 MHz and can vary ± 10% across the band.
3. Ice shields are strongly recommended for areas subject to icing conditions. Dielectric is not responsible for antenna damage caused by impact from falling ice.
4. Calculated area (CaAc) expressed in TIA/EIA-222-F standard.
5. Specs. are for a single DCR-S antenna array or HDR-S antenna array, not both.

With Radomes				With Deicers			
Weight lbs (kg)		CaAc ft ² (m ³)		Weight lbs (kg)		CaAc ft ² (m ³)	
λ Spaced	$\frac{1}{2} \lambda$ Spaced	λ Spaced	$\frac{1}{2} \lambda$ Spaced	λ Spaced	$\frac{1}{2} \lambda$ Spaced	λ Spaced	$\frac{1}{2} \lambda$ Spaced
335 (152)	—	11.2 (1.0)	—	197 (89)	—	7.7 (.7)	—
607 (275)	592 (269)	22.1 (2.1)	20.6 (1.9)	332 (151)	317 (144)	15.1 (1.4)	13.6 (1.3)
879 (394)	849 (385)	33.0 (3.1)	30.0 (2.8)	466 (211)	436 (198)	22.5 (2.1)	19.5 (1.8)
1151 (522)	1106 (502)	43.9 (4.1)	39.4 (3.7)	601 (273)	556 (252)	29.9 (2.8)	25.4 (2.4)
1423 (645)	1363 (618)	54.9 (5.1)	48.9 (4.5)	735 (333)	675 (306)	37.3 (3.5)	31.3 (2.9)
1695 (769)	1620 (733)	65.8 (6.1)	58.3 (5.4)	870 (395)	795 (361)	44.7 (4.2)	37.2 (3.5)
1967 (892)	1877 (851)	76.6 (7.1)	67.6 (6.3)	1004 (455)	914 (415)	52 (4.8)	43 (4.0)
2239 (1016)	2134 (968)	87.8 (8.2)	77.3 (7.2)	1182 (536)	1033 (468)	59.7 (5.5)	49.2 (4.6)
2753 (1249)	2618 (1188)	110.0 (10.2)	96.5 (9.0)	1451 (658)	1286 (583)	74.5 (6.9)	61 (5.7)
3267 (1481)	3102 (1407)	131.0 (12.2)	115.0 (10.6)	1720 (780)	1555 (705)	89.3 (8.3)	72.8 (6.8)

Electrical Specifications

Antenna Type DCR-S or HDR-S	Gain Polarization Spacing ¹				Power Rating kW ³
	λ Spacing		$\frac{1}{2} \lambda$ Spacing		
	Power Gain	dB	Power Gain	dB	
DCR-S1 HDR-S1	0.46	-3.37	—	—	28
DCR-S2 HDR-S2	1.0	0	0.7	-1.55	40
DCR-S3 HDR-S3	1.5	1.76	1.0	0	40
DCR-S4 HDR-S4	2.1	3.22	1.3	1.14	40
DCR-S5 HDR-S5	2.7	4.31	1.6	1.76	40
DCR-S6 HDR-S6	3.2	5.05	1.8	2.55	40
DCR-S7 HDR-S7	3.8	5.80	2.1	3.22	40
DCR-S8 HDR-S8	4.3	6.34	2.3	3.62	40
DCR-S10 HDR-S10	5.5	7.40	2.9	4.62	40
DCR-S12 HDR-S12	6.6	8.2	3.5	5.44	40

Notes:

1. RMS gain data is given relative to dipole. Values are for midband and include standard harness configurations. Actual gain will vary depending on feed system, frequency, null fill, and beam tilt.
2. Average power ratings are nominal @ 40°C (104°F) ambient. Assumes constant pressurization with dry air or nitrogen. Ratings may vary based on specific feed system design and local conditions.
3. Higher power ratings and custom feed systems may be available on request.
4. Antenna components and feed harnesses are optimized for FM channels of interest.
5. Specifications are for a single DCR-S antenna array or HDR-S antenna array, not both.

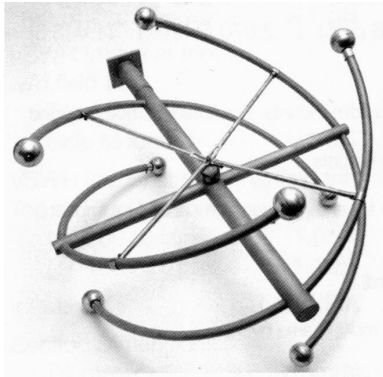

DCR-MFE "FUNKY ELBOW"

- Variable spacing
- Broad bandwidth capability
- Array input power 100kW or more
- Series fed for multi-station operation
- Circularly polarized
- Stainless steel construction
- Low ice sensitivity
- Fine matcher included
- Match bay spacing to existing tower for more consistent pattern results
- Radomes/deicers available



The DCR-MFE antenna is center fed, meeting the needs of high-power, high bandwidth and short spaced bay requirements.

Variable Bay Spacing

Through the use of a series feed system, proper RF phase to each bay is maintained, even at reduced bay spacings. This allows for bay spacings between 1/2 and full wavelength. The reduction in bay spacing can have multiple benefits including: 1) A significant reduction in the amount of "downward" radiation. 2) Broader elevation beam. 3) More constant patterns.

It must be noted that reducing the bay spacing for a given number of bays also reduces the gain. An 8 bay with full wavelength spacing has a gain of 4.3x. The elevation pattern of an 8 bay half wavelength with a gain of 2.4x resembles the elevation pattern of a 4 bay full wavelength in terms of beam width and gain. A variety of bay spacing is available; contact factory for details.

High-Power Input Capability

The DCR-M is designed with input line sizes up to 6-1/8" EIA. This allows for array input power levels in excess of 100kW.

Beam Tilt & Null Fill

Beam tilt and/or null fill are options typically offered in arrays of eight bays or more, however they may also be utilized on smaller arrays.

Directional Arrays

The DCR-MFE antenna is available in directional arrays which are custom-built to the needs of the specific station.

Multi-Station Operation

The high-power handling and wideband characteristics for the DCR-MFE make this antenna an excellent alternative to high cost panel antennas.

To aid in selecting the elevation pattern most suitable to your application, please visit our website and download Dielectric's Antenna Planning software.

General Specifications

Pattern Circularity in Free Space	± 1 dB
VSWR (max.) at Input, Up to 8 MHz	1.15:1 typical, call for quote on specific application
Input	3 1/8" 50 ohm Standard, larger sizes available
Section Dimensions	Diameter: 36" (915mm) / Height: 29" (737mm)

Mechanical Specifications

Antenna Type	# of Bays	Without Radomes			
		Weight lbs (kg)		EPA (ft ²)	
		λ Spaced	$1/2 \lambda$ Spaced	λ Spaced	$1/2 \lambda$ Spaced
DCRM-1 HCRM-1	1	121		5	
DCRM-2 HCRM-2	2	207	200	9.9	8.4
DCRM-3 HCRM-3	3	294	280	14.7	11.8
DCRM-4 HCRM-4	4	380	360	19.6	15.2
DCRM-5 HCRM-5	5	467	440	24.4	18.6
DCRM-6 HCRM-6	6	553	519	29.3	22
DCRM-7 HCRM-7	7	640	599	34.1	25.4
DCRM-8 HCRM-8	8	726	679	39	28.8
DCRM-10 HCRM-10	10	900	839	48.7	35.5
DCRM-12 HCRM-12	12	1073	998	58.4	42.3

Loads per ANSI/TIA 222G, reference frequency 98Mhz, end fed antenna

Notes:

- Weights include bays and standard extension brackets for mounting. Excludes feed system and custom mounts. For antennas that included pattern studies, contact factory for additional information.
- Projected area includes bays and standard extension brackets. Excludes feed system and custom mounts.
- Dimensions are for antennas at 98.0 MHz and can vary $\pm 10\%$ across the band.
- Ice shields are strongly recommended for areas subject to tower icing. Dielectric is not responsible for antenna damage caused by impact from falling ice.
- Area calculated expressed in terms of equivalent flats (RS-222-C standard).
- Windload force calculated based on 50 pounds per square foot (50psf) on flats (RS-222-C standard).
- To convert area to equivalent rounds, multiply area by 1.5.
- To convert area to Aerodynamic area (CaAa - linear or CaAc - discrete) based on EIA-222-G standard, multiply area by 1.8.

With Radomes				With Deicers			
Weight lbs (kg)		EPA (ft ²)		Weight lbs (kg)		EPA (ft ²)	
λ Spaced	$1/2 \lambda$ Spaced	λ Spaced	$1/2 \lambda$ Spaced	λ Spaced	$1/2 \lambda$ Spaced	λ Spaced	$1/2 \lambda$ Spaced
174		7.3		126		6.3	
314	207	14.5	13	217	210	12.6	10.9
454	440	21.6	18.7	309	295	18.9	15.4
594	574	28.7	24.4	400	380	25.2	20
734	707	35.9	30	492	465	31.5	24.6
874	840	43	35.7	583	549	37.8	29.2
1014	973	50.2	41.4	675	634	44.1	33.7
1154	1106	57.3	47.1	766	719	50.5	38.3
1434	1373	71.6	58.4	950	889	63.1	47.5
1713	1639	85.9	69.8	1133	1058	75.7	56.6

Deicer Specifications

Power (nominal, per bay): 1200 W
 Voltage: May be wired for 208V or 240V service, single- or three-phase

Optional

Ice sensor and deicer controller.

Electrical Specifications

Gain Polarization Spacing¹

Antenna Type	³ / ₄ λ Spacing		⁷ / ₈ λ Spacing		Power Rating kW ³
	Power Gain	dB	Power Gain	dB	
DCR-MFE4	1.80	2.55	2.1	3.22	40
DCR-MFE6	2.70	4.31	3.1	4.91	40
DCR-MFE8	3.60	5.56	4.1	6.12	40
DCR-MFE10	4.50	6.53	5.1	7.08	40
DCR-MFE12	5.40	7.32	6.1	7.85	40

Notes:

1. RMS gain data is given relative to dipole. Values are for each polarization and nominal for midband and include standard harness configurations. Actual gain will vary depending on feed system, frequency, null fill, and beam tilt.
2. Average power ratings are nominal @ 40°C ambient. Assumes constant pressurization with dry air or nitrogen. Ratings may vary based on specific feed system design and local conditions.
3. Higher power ratings and custom feed systems may be available on request.
4. Antenna components and feed harnesses are optimized for FM channels of interest.



DCR-M / HDR-M

- DCR-M: Right Hand Circularly Polarized
- HDR-M: Left Hand Circularly Polarized
- DCR-M/HDR-M IBOC compatible
- Interleaved provides -40 dB of isolation
- Stainless steel elements
- Ideal for Class B and C stations
- 18 kW for a single bay
- Fine matcher included
- Radomes or integral deicers optional
- VSWR field adjustable

The DCR-M/HDR-M has been used extensively for high-power broadband applications. The “M” series antennas are circularly polarized with a power rating of 18 kW for a single bay and are available in stacked arrays of up to 16 bays with an input rating to 40 kW. For situations where ice formation is common, the arrays can be equipped with optional electrical deicers or radomes. The antenna is DC grounded and does not require shorting stubs. Each array is supplied with an input fine matcher for field optimization. For reduced downward radiation, the use of a custom feed design allows for shorter spacings in a series fed configuration.

High-Power Input Capability

The “M” series antenna is available with optional 4 1/16” feed system having a power input rating (for five or more bays) of 70 kW. Arrays w/ 6 1/8” inputs are also available.

Multi-Station Operation

The wide bandwidth of high-power input capability of the “M” series antenna permits optional multi-station operation.

Beam Tilt & Null Fill

Beam tilt and/or null fill are available options. These options are ordinarily specified for arrays of 8 bays or more. Even numbered arrays of six sections and fewer may include one or both options and typically are designed as a center-fed array. The “M” series antenna is available in directional arrays which are custom-built to the needs of the station.

Quadrupole Design

The four-dipole-per-element design offers the advantage of more symmetrical azimuth pattern performance and H/V ratio than dual dipole designs, providing more robust coverage.

Low downward radiation options available—contact factory.

General Specifications

Polarization	Circular
Pattern Circularity in Free Space	± 1 dB
VSWR (max.) at Input, w/o field trim	Top Mounted: 1.2:1 / Side Mounted: 1.5:1
VSWR (max.) at Input, w/ field trim	Top Mounted: (±200 KHz) 1.05:1 / Side Mounted: (±400 KHz) 1.10:1
Bay Dimensions (w/o Radome)	Diameter: 36" (915mm) / Height: 29" (737mm)
Bay Dimensions (w/ Radome)	Diameter: 44" (1118mm) / Height: 34" (864mm)

Mounting Dimensions

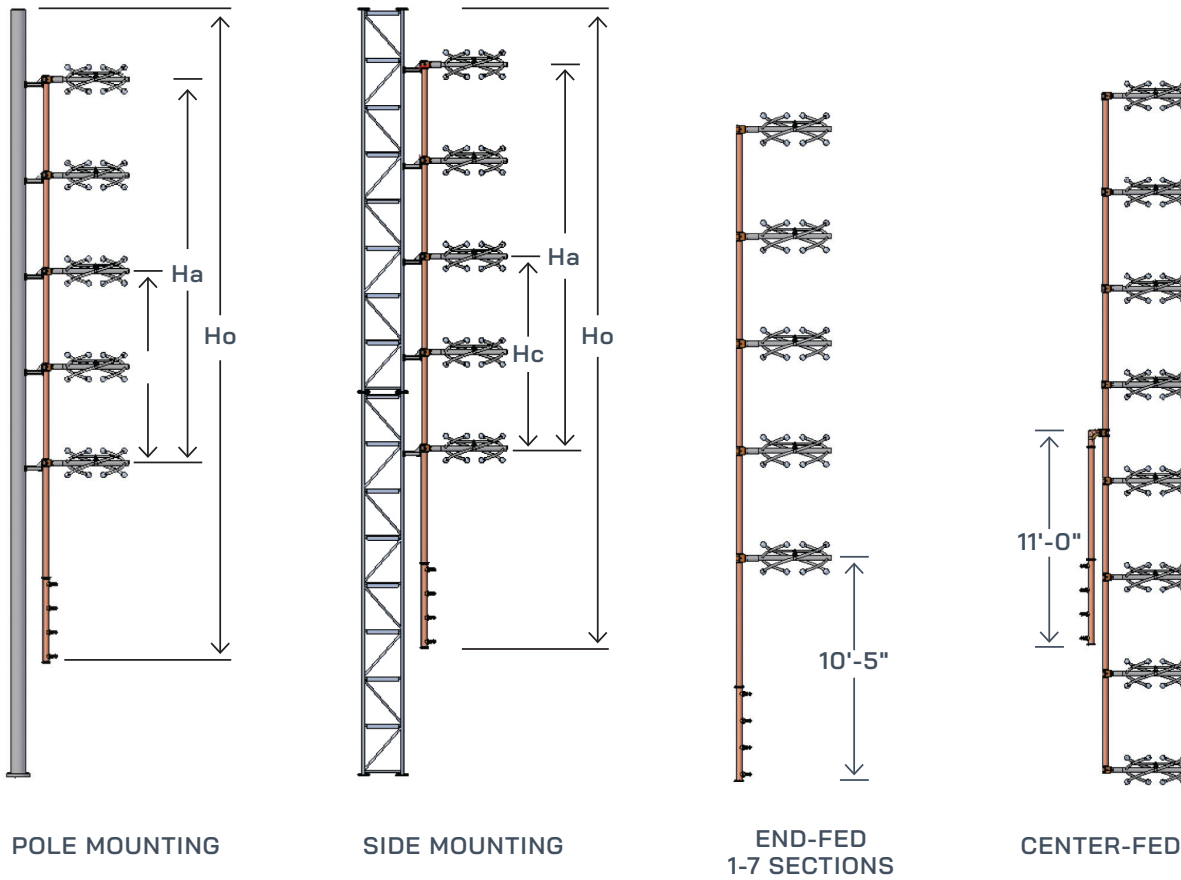

H_a = Antenna aperture length
 H_c = Antenna center of radiation
 H_o = Antenna overall length needed for mounting
 $H_a = 984/f \times [s(x-1)]$
 $H_c = H_a/2$
 $H_o = H_a + 5' + 10' - 5"$
 $H_o = H_a + 5' + 5'$

All dimensions in feet
 f = frequency in megahertz (MHz)
 s = bay spacing in fraction of wavelengths
 example: $\frac{1}{2}$ wavelength = .5
 x = number of antenna bays

Note: Antennas ordered w/beam tilt and/or null fill are supplied with center feed and require an even number of bays.

Power (nominal per bay): 1200 W
 Voltage: may be wired for 208 V or 240 V service, single or three phase.

Optional

Ice sensor and deicer controller.

Mechanical Specifications

Without Radomes					
Antenna Type	# of Bays	Weight lbs (kg)		EPA (ft ²)	
		λ Spaced	$1/2 \lambda$ Spaced	λ Spaced	$1/2 \lambda$ Spaced
DCRM-1 HCRM-1	1	121		5	
DCRM-2 HCRM-2	2	207	200	9.9	8.4
DCRM-3 HCRM-3	3	294	280	14.7	11.8
DCRM-4 HCRM-4	4	380	360	19.6	15.2
DCRM-5 HCRM-5	5	467	440	24.4	18.6
DCRM-6 HCRM-6	6	553	519	29.3	22
DCRM-7 HCRM-7	7	640	599	34.1	25.4
DCRM-8 HCRM-8	8	726	679	39	28.8
DCRM-10 HCRM-10	10	900	839	48.7	35.5
DCRM-12 HCRM-12	12	1073	998	58.4	42.3

Loads per ANSI/TIA 222G, reference frequency 98Mhz, end fed antenna

Notes:

1. CaAc and weight includes bays and standard extension brackets for mounting. Excludes custom mounts. For antennas that include pattern studies, contact factory for additional information.
2. Dimensions are for antennas at 98.0 MHz and can vary $\pm 10\%$ across the band.
3. Ice shields are strongly recommended for areas subject to icing conditions. Dielectric is not responsible for antenna damage caused by impact from falling ice.
4. Calculated area (CaAc) expressed in TIA/EIA-222-G standard.
5. Specs. are for a single DCR-M antenna array or HDR-M antenna array, not both.

With Radomes				With Deicers			
Weight lbs (kg)		EPA (ft ²)		Weight lbs (kg)		EPA (ft ²)	
λ Spaced	$\frac{1}{2} \lambda$ Spaced	λ Spaced	$\frac{1}{2} \lambda$ Spaced	λ Spaced	$\frac{1}{2} \lambda$ Spaced	λ Spaced	$\frac{1}{2} \lambda$ Spaced
174		7.3		126		6.3	
314	207	14.5	13	217	210	12.6	10.9
454	440	21.6	18.7	309	295	18.9	15.4
594	574	28.7	24.4	400	380	25.2	20
734	707	35.9	30	492	465	31.5	24.6
874	840	43	35.7	583	549	37.8	29.2
1014	973	50.2	41.4	675	634	44.1	33.7
1154	1106	57.3	47.1	766	719	50.5	38.3
1434	1373	71.6	58.4	950	889	63.1	47.5
1713	1639	85.9	69.8	1133	1058	75.7	56.6

Electrical Specifications

Antenna Type DCR-S or HDR-S	Gain Polarization Spacing ¹				Power Rating kW ³
	λ Spacing		$\frac{1}{2} \lambda$ Spacing		
	Power Gain	dB	Power Gain	dB	
DCR-M1 HDR-M1	0.46	-3.37	—	—	18
DCR-M2 HDR-M2	1.0	0	0.7	-1.55	36
DCR-M3 HDR-M3	1.5	1.76	1.0	0	40
DCR-M4 HDR-M4	2.1	3.22	1.3	1.14	40
DCR-M5 HDR-M5	2.7	4.31	1.6	1.76	40
DCR-M6 HDR-M6	3.2	5.05	1.8	2.55	40
DCR-M7 HDR-M7	3.8	5.80	2.1	3.22	40
DCR-M8 HDR-M8	4.3	6.34	2.3	3.62	40
DCR-M10 HDR-M10	5.5	7.40	2.9	4.62	40
DCR-M12 HDR-M12	6.6	8.2	3.5	5.44	40

Notes:

1. RMS gain data is given relative to dipole. Values are for midband and include standard harness configurations. Actual gain will vary depending on feed system, frequency, null fill, and beam tilt.
2. Average power ratings are nominal @ 40°C ambient. Assumes constant pressurization with dry air or nitrogen. Ratings may vary based on specific feed system design and local conditions.
3. Higher power ratings and custom feed systems may be available on request.
4. Antenna components and feed harnesses are optimized for FM channels of interest.
5. Specs. are for a single DCR-M antenna array or HDR-M antenna array, not both.

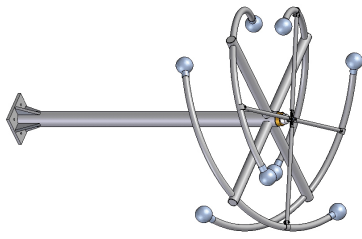

DCR-MT SERIES QUADRAPOLE ANTENNA

- 18 kW per bay
- Omnidirectional within 1 dB
- Circularly polarized
- Stainless steel construction
- Pole or tower top mount
- Broadband
- Low ice sensitivity, deicers optional

The DCR-MT top mount version of the popular quadrapole antenna is specifically designed for those applications where a near perfectly omnidirectional signal is desired. This antenna is designed to be self-supporting above the top of the mounting structure, thus eliminating the pattern distortion that is caused by mounting the antenna on the side of a metal tower or pole.

The high strength stainless steel construction provides an extremely rugged radiating element that imposes minimal windload on the mounting structure. The antenna base flange is designed to attach to a standard 6" pipe flange. The inside diameter of a 6" pipe is large enough to pass a standard 3 1/8" coax flange to feed the antenna. This antenna is currently available in a single bay design. It is conservatively rated for 18 kW of input power. For more information on this or other Dielectric products, please contact our factory.

Electrical Specifications

Antenna Type	Gain ¹ Power (dB) ¹	Power Rating kW ³
DCR-MT 1	0.46 (-3.37)	18

Notes:

1. Power gain in each polarization
2. Power rating based on 40°C (104°F) ambient. Multiply values listed by 0.8 for 50°C (122°F) ambient. DCT-MT with greater power ratings are available.

General Specifications

Polarization	Circular
Pattern Circularity in Free Space	± 1 dB
VSWR (max.) at Input w/o field trim	Top Mounted (±200 KHz) 1.05:1
Input	3 1/8" EIA
Section Dimensions	Diameter: 36" (915mm) / Height: 60" (1525mm)



DCR-C / HDR-C

- DCR-C: Right Hand Circularly Polarized
- HDR-C: Left Hand Circularly Polarized
- DCR-C/HDR-C IBOC compatible
- Interleaved provides -40 dB of isolation
- Stainless steel elements
- Ideal for Class B and C stations
- 10 kW for a single bay
- Fine matcher included
- Radomes or integral deicers optional
- VSWR field adjustable

The DCR-C/HDR-C is circularly polarized with a power rating of 10 kW for a single bay, and is available in stacked arrays of up to 12 bays with an input rating to 40 kW. 14 and 16-bay arrays are available with special VSWR specifications. For situations where ice formation is common, the arrays can be equipped with optional electrical deicers or radomes. The antenna is DC grounded for lightning protection and does not require shorting stubs. Each array is supplied with an input fine matcher for field optimization.

End-Fed or Center-Fed Arrays

Two power distribution methods are used with the DCR-C/HDR-C antenna. The array is usually end-fed unless it includes beam tilt and/or null fill. In this case, the sections are fed from a center point. The input connection in either case is 3 1/8" EIA.

Beam Tilt & Null Fill

Beam tilt and/or null fill are optional extras on the DCR-C/HDR-C series. These options are ordinarily specified for arrays of 8 bays or more. Arrays with 6 bays or less may include one or both options and typically are designed as a center-fed array.

Directional Arrays

The DCR-C/HDR-C antenna series is available in directional arrays which are custom-built to the needs of the station.

General Specifications

Polarization	Circular
Pattern Circularity in Free Space	± 1 dB
VSWR (max.) at Input, w/o field trim	Top Mounted: 1.2:1 / Side Mounted: 1.5:1
VSWR (max.) at Input, w/ field trim, Top or Side Mounted	(100 KHz) 1.07:1
Input	3 1/8" EIA
Bay Dimensions (w/o Radome)	Diameter: 20.7" (526mm) / Height: 20" (503mm)
Bay Dimensions (w/ Radome)	Diameter: 30" (762mm) / Height: 29" (737mm)

Mounting Dimensions

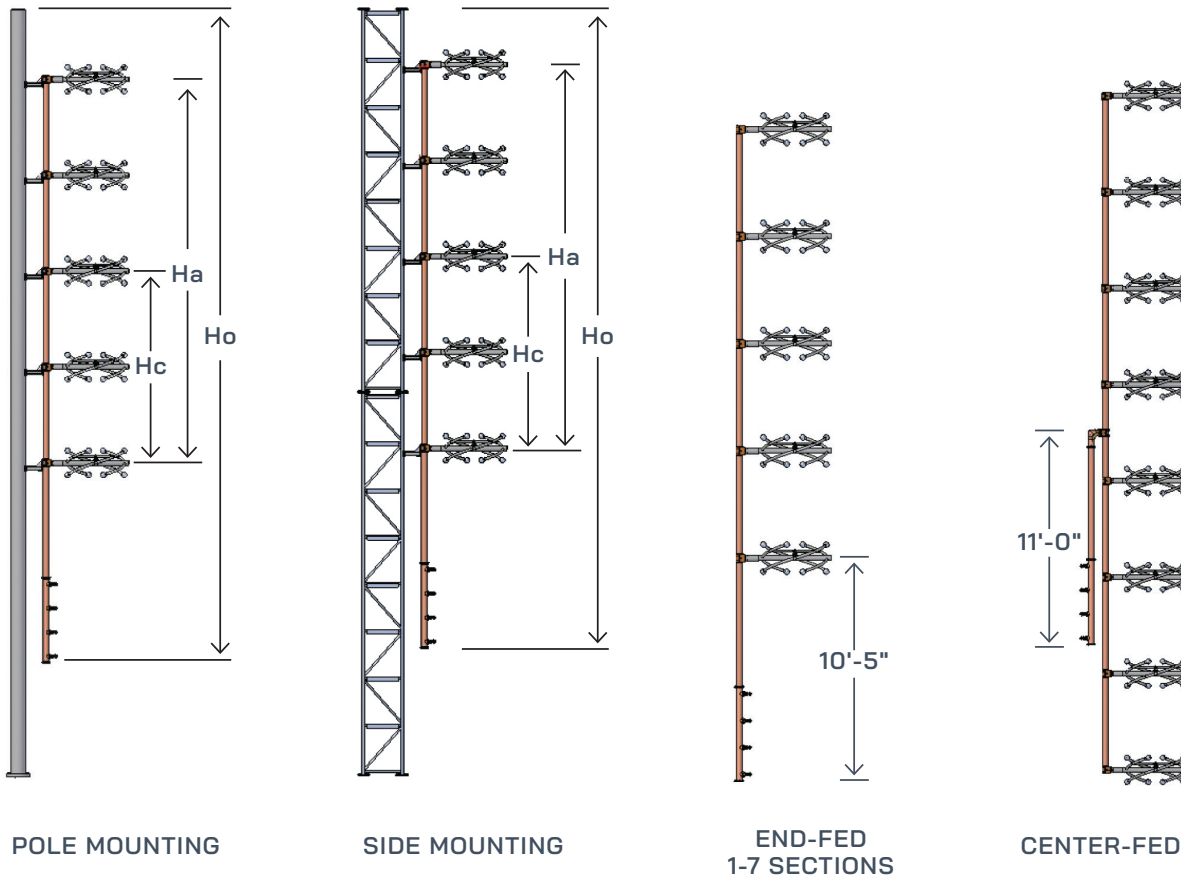

H_a = Antenna aperture length
 H_c = Antenna center of radiation
 H_o = Antenna overall length needed for mounting
 $H_a = 984/f \times [s(x-1)]$
 $H_c = H_a/2$
 $H_o \text{ end-fed} = H_a + 5' \text{ top} + 10' - 5'' \text{ bottom}$
 $H_o \text{ center-fed} = H_a + 5' \text{ top} + 5' \text{ bottom}$
 All dimensions in feet
 f = frequency in megahertz (MHz)
 s = bay spacing in fraction of wavelengths
 example: $\frac{1}{2}$ wavelength = .5
 x = number of antenna bays

Note: Antennas ordered w/beam tilt and/or null fill are supplied with center feed and require even number of bays.

Deicer Specifications:
 Power (nominal per bay): 1200 W
 Voltage: may be wired for 208 V or 240 V service, single or three phase.

Deicer Specifications

Power (nominal, per bay): 600 W
 Voltage: May be wired for 208 V or 240 V service, single- or three-phase

Optional

Ice sensor and deicer controller.

Mechanical Specifications

Without Radomes					
Antenna Type	# of Bays	Weight lbs (kg)		EPA (ft ²)	
		λ Spaced	$1/2 \lambda$ Spaced	λ Spaced	$1/2 \lambda$ Spaced
DCRC-1 HCRC-1	1	57		3	
DCRC-2 HCRC-2	2	104	98	6.1	5.2
DCRC-3 HCRC-3	3	152	138	9.1	7.5
DCRC-4 HCRC-4	4	200	179	12.1	9.7
DCRC-5 HCRC-5	5	247	220	15.2	11.9
DCRC-6 HCRC-6	6	295	261	18.2	14.1
DCRC-7 HCRC-7	7	342	302	21.2	16.3
DCRC-8 HCRC-8	8	390	342	24.3	18.6
DCRC-10 HCRC-10	10	485	424	30.4	23
DCRC-12 HCRC-12	12	580	505	36.4	27.5

Loads per ANSI/TIA 222G, reference frequency 98Mhz, end fed antenna

Notes:

1. CaAc and weights include bays and standard extension brackets for mounting. Excludes feed custom mounts. For antennas that include pattern studies, contact factory for additional information.
2. Dimensions are for antennas at 98.0 MHz and can vary $\pm 10\%$ across the band.
3. Ice shields are strongly recommended for areas subject to icing conditions. Dielectric is not responsible for antenna damage caused by impact from falling ice.
4. Calculated area (CaAc) expressed in TIA/EIA-222-F standard.
5. Specs. are for a single DCR-C antenna array or HDR-C antenna array, not both.

With Radomes				With Deicers			
Weight lbs (kg)		EPA (ft ²)		Weight lbs (kg)		EPA (ft ²)	
λ Spaced	$\frac{1}{2} \lambda$ Spaced	λ Spaced	$\frac{1}{2} \lambda$ Spaced	λ Spaced	$\frac{1}{2} \lambda$ Spaced	λ Spaced	
87		5.1		62		4.9	
164	158	10.2	9.4	114	108	9.8	9
242	228	15.3	13.7	167	153	14.7	13
320	299	20.4	18	220	199	19.6	17.1
397	370	25.5	22.3	272	245	24.4	21.2
475	441	30.7	26.6	325	291	29.3	25.3
552	512	35.8	30.9	377	337	34.2	29.3
630	582	40.9	35.2	430	382	39.1	33.4
785	724	51.1	43.8	535	474	48.9	41.6
940	865	61.3	52.4	640	565	58.7	49.7

Electrical Specifications

Antenna Type	Gain Polarization Spacing ¹				Power Rating kW ³
	λ Spacing		$\frac{1}{2} \lambda$ Spacing		
	Power Gain	dB	Power Gain	dB	
DCR-C1 HDR-C1	0.46	-3.37	—	—	10
DCR-C2 HDR-C2	1.0	0	0.7	-1.55	20
DCR-C3 HDR-C3	1.5	1.76	1.0	0	30
DCR-C4 HDR-C4	2.1	3.22	1.3	1.14	40
DCR-C5 HDR-C5	2.7	4.31	1.6	2.04	40
DCR-C6 HDR-C6	3.2	5.05	1.8	2.55	40
DCR-C7 HDR-C7	3.8	5.80	2.1	3.22	40
DCR-C8 HDR-C8	4.3	6.34	2.4	3.8	40
DCR-C10 HDR-C10	5.5	7.40	3.1	4.91	40
DCR-C12 HDR-C12	6.6	8.2	3.7	5.68	40

Notes:

1. RMS gain data is given relative to dipole. Values are for midband and include standard harness configurations. Actual gain will vary depending on feed system, frequency, null fill, and beam tilt.
2. Average power ratings are nominal @ 40°C ambient. Assumes constant pressurization with dry air or nitrogen. Ratings may vary based on specific feed system design and local conditions.
3. Higher power ratings and custom feed systems may be available on request.
4. Antenna components and feed harnesses are optimized for FM channels of interest.
5. Specs. are for a single DCR-C antenna array or HDR-C antenna array, not both.



DCR-H / HDR-H

- DCR-H: Right Hand Circularly Polarized
- HDR-H: Left Hand Circularly Polarized
- DCR-H/HDR-H IBOC compatible
- Interleaved provides -40 dB of isolation
- Stainless steel elements
- Ideal for Class A and B stations
- 4 kW for a single bay
- Fine matcher included
- Radomes or integral deicers optional
- VSWR field adjustable
- No circulators required

The DCR-H/HDR-H antenna is a low-power version of the DCR-C/HDR-C and is available in one through twelve bays with an input power rating up to 12 kW. Each array is supplied with an input fine matcher for field optimization. For situations where ice formation is common, the arrays can be equipped with optional electrical deicers or radomes. The antenna is DC grounded for lightning protection and does not require shorting stubs. Each array is supplied with an input fine matcher for field optimization.

End-Fed or Center-Fed Arrays

Two power distribution methods are used with the DCR-H/HDR-H antenna. The array is usually end-fed unless it includes beam tilt and/or null fill. In this case, the sections are fed from a center point. The input connection in either case is 1 5/8" EIA.

Beam Tilt & Null Fill

Beam tilt and/or null fill are optional extras on the DCR-H/HDR-H series. If optional beam tilt or null fill is specified, the antenna is designed as a center-fed array.

Directional Arrays

The DCR-H/HDR-H antenna is available in directional arrays which are custom-built to the needs of the station.

Low downward radiation options available – contact factory.

General Specifications

Polarization	Circular
Pattern Circularity in Free Space	± 1 dB
VSWR (max.) at Input w/o field trim	Top Mounted: 1.2:1 / Side-Mounted: 1.5:1
VSWR (max.) at Input w/ field trim, Top or Side Mounted (± 100 KHz)	1.07:1
Input	1 1/8" EIA
Bay Dimensions (w/o Radome)	Diameter: 20.7" (526mm) / Height: 20" (503mm)

Mounting Dimensions

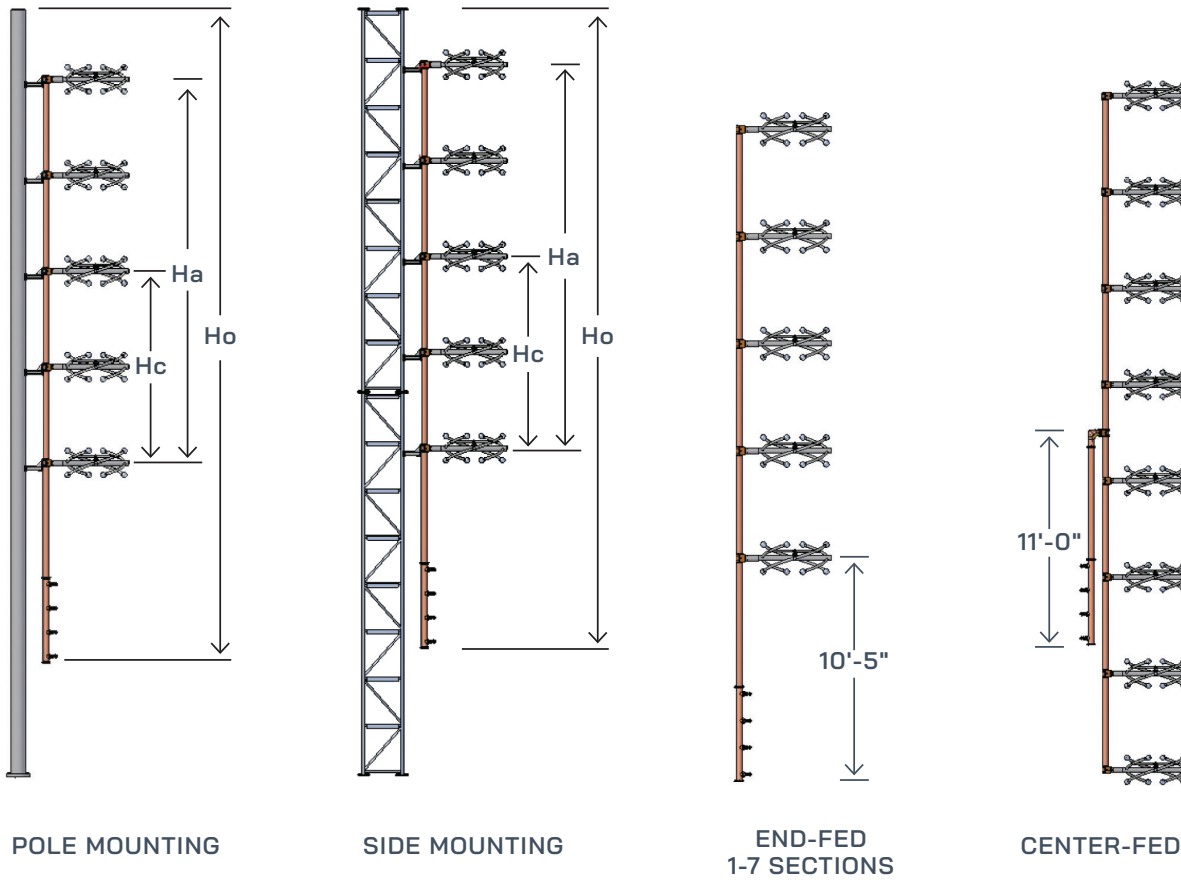

H_a = Antenna aperture length
 H_c = Antenna center of radiation
 H_o = Antenna overall length needed for mounting
 $H_a = 984/f \times [s(x-1)]$
 $H_c = H_a/2$
 $H_o \text{ end-fed} = H_a + 5' \text{ top} + 10' - 5'' \text{ bottom}$
 $H_o \text{ center-fed} = H_a + 5' \text{ top} + 5' \text{ bottom}$
 All dimensions in feet
 f = frequency in megahertz (MHz)
 s = bay spacing in fraction of wavelengths
 example: $\frac{1}{2}$ wavelength = .5
 x = number of antenna bays

Note: Antennas ordered w/beam tilt and/or null fill are supplied with center feed and require even number of bays.

Deicer Specifications:
 Power (nominal per bay): 600 W
 Voltage: may be wired for 208 V or 240 V service, single or three phase.

Deicer Specifications

Power (nominal, per bay): 600 W
 Voltage: May be wired for 208 V or 240 V service, single- or three-phase

Optional

Ice sensor and deicer controller.

Electrical Specifications

Antenna Type DCR-H or HDR-H	Gain Polarization Spacing				Power Rating kW ³
	λ Spacing		$\frac{1}{2} \lambda$ Spacing		
	Power Gain	dB	Power Gain	dB	
DCR-H1 HDR-H1	0.46	-3.37	—	—	4
DCR-H2 HDR-H2	1.0	0	0.7	-1.55	8
DCR-H3 HDR-H3	1.5	1.76	1.0	0	12
DCR-H4 HDR-H4	2.1	3.22	1.3	1.14	12
DCR-H5 HDR-H5	2.7	4.31	1.6	1.76	12
DCR-H6 HDR-H6	3.2	5.05	1.8	2.55	12
DCR-H7 HDR-H7	3.8	5.80	2.1	3.22	12
DCR-H8 HDR-H8	4.3	6.34	2.4	3.80	12
DCR-H10 HDR-H10	5.5	7.40	3.0	4.77	12
DCR-H12 HDR-H12	6.6	8.2	3.6	5.56	12

Notes:

1. RMS gain data is given relative to dipole. Values are for midband and include standard harness configurations. Actual gain will vary depending on feed system, frequency, null fill, and beam tilt.
2. Average power ratings are nominal @ 40°C ambient. Assumes constant pressurization with dry air or nitrogen. Ratings may vary based on specific feed system design and local conditions.
3. Higher power ratings and custom feed systems may be available on request.
4. Antenna components and feed harnesses are optimized for FM channels of interest.
5. Specs. are for a single DCR-H antenna array or HDR-H antenna array, not both.

Mechanical Specifications

Without Radomes					
Antenna Type	# of Bays	Weight lbs (kg)		EPA (ft ²)	
		λ Spaced	$1/2 \lambda$ Spaced	λ Spaced	$1/2 \lambda$ Spaced
DCRH-1 HCRH-1	1	82		4	
DCRH-2 HCRH-2	2	129	122	7.7	6.3
DCRH-3 HCRH-3	3	177	163	11.5	8.6
DCRH-4 HCRH-4	4	224	204	15.3	10.9
DCRH-5 HCRH-5	5	272	245	19.1	13.2
DCRH-6 HCRH-6	6	319	285	22.9	15.6
DCRH-7 HCRH-7	7	367	326	26.6	17.9
DCRH-8 HCRH-8	8	414	367	30.4	20.2
DCRH-10 HCRH-10	10	510	449	38	24.8
DCRH-12 HCRH-12	12	605	530	45.6	29.5

Loads per ANSI/TIA 222G, reference frequency 98Mhz, end fed antenna

Notes:

1. CaAc and weights include bays and standard extension brackets for mounting. Excludes feed custom mounts. For antennas that include pattern studies, contact factory for additional information.
2. Dimensions are for antennas at 98.0 MHz and can vary $\pm 10\%$ across the band.
3. Ice shields are strongly recommended for areas subject to icing conditions. Dielectric is not responsible for antenna damage caused by impact from falling ice.
4. Calculated area (CaAc) expressed in TIA/EIA-222-G standard.
5. Specs. are for a single DCR-H antenna array or HDR-H antenna array, not both.

With Randomes				With Deicers			
Weight lbs (kg)		EPA (ft ²)		Weight lbs (kg)		EPA (ft ²)	
λ Spaced	$\frac{1}{2} \lambda$ Spaced	λ Spaced	$\frac{1}{2} \lambda$ Spaced	λ Spaced	$\frac{1}{2} \lambda$ Spaced	λ Spaced	
112		6.4		87		6	
189	182	12.5	11.1	139	132	12.1	10.3
267	253	18.7	15.8	192	178	18.1	14.7
344	324	24.9	20.5	244	224	24.2	19
422	395	31.1	25.2	297	270	30.2	23.3
499	465	37.2	29.9	349	315	36.3	27.6
577	536	43.4	34.6	402	361	42.4	32
654	607	49.6	39.3	454	407	48.4	36.3
810	749	61.9	48.8	560	499	60.5	44.9
965	890	74.3	58.2	665	590	72.6	53.6

BROADBAND SYSTEMS FOR MULTIPLEXING SIGNALS



DCR-S / DCR-M

- Superior bandwidth for analog or -10 dB IBOC, or both
- Broadband arrays from $\frac{1}{2}$ wave spaced to full wave spacing (see chart)
- Arrays from 2 to 12 bays
- Circular polarization
- Left or right hand polarization
- Full FM band operation available in $\frac{1}{2}$ spaced arrays
- Low VSWR
- Series fed arrays
- High input power capability
- Simple design leads to ease of installation
- Common amplification or high level combined with single input
- Beam tilt and null fill available
- Radomes or deicers available

Dielectric offers DCR-M and DCR-S models at $\frac{1}{2}$ wavelength spacing that can cover the entire FM band for purposes of multiplexing signals. The broadband DRCM and DCR-S antennas can be fed with a single line input or a dual input for redundancy purposes.

The input power can be significantly higher than our DCR-M models and we can feed with dual 6" inputs. Average power ranges from 40 kW to over 120 kW are available and each system is quickly designed to meet the needs of the broadcaster and market they serve.

The antenna design is offered with customer required beam tilt and null fill requirements. Custom selections are engineered and manufactured at our facility. In addition, both the DCR-M and DCR-S are offered with heaters and radomes.

The full band operation allows broadcasters to simulcast from one antenna. The antenna is designed to handle the peak power of multiple signals including IBOC signals at -10 dB. The DCR-S was designed to handle more stations at a higher safety margin for multiple signals including IBOC at -10 dB. The higher peak power design should be considered. Dielectric takes pride in the safe power levels at the design stage to ensure the broadcaster has an antenna that will produce sound quality signals for many years.

BROADBAND SYSTEMS FOR MULTIPLEXING SIGNALS

Dielectric FM Achievable Bandwidths

E = END FED C- CENTER FED

	$\frac{1}{2}$ Wave Spaced	Funky Elbow	Full Wave Spaced
2E	15 MHz	7 MHz	5 MHz
2C	12 MHz	7 MHz	5 MHz
3E	15 MHz	7 MHz	5 MHz
4E	8 MHz	5 MHz	3 MHz
4C	15 MHz	7 MHz	5 MHz
5E	6 MHz	4 MHz	3 MHz
5C	15 MHz	7 MHz	5 MHz
6E	5 MHz	4 MHz	3 MHz
6C	15 MHz	7 MHz	5 MHz
8C	8 MHz	5 MHz	3 MHz
10C	15 MHz	7 MHz	5 MHz
12C	15 MHz	7 MHz	5 MHz

Notes:

Discuss additional bandwidth considerations with Dielectric sales representative.
 Additional bandwidths available upon request.
 Refer to DCR-S/HDR-S (pg 16-20) and DCR-M/HDR-M (pg 24-28) for specifications.

DCR-S / DCR-M

- Circular polarization
- Left or right hand polarization
- Full FM band operation
- Low VSWR
- Series fed arrays
- High input power capability
- Simple design leads to ease of installation
- Designed for analog and -10 dB IBOC signals
- Common amplification or high level combined with single input
- 1/2 wave spaced arrays
- Beam tilt and null fill available
- Radomes or deicers available

Dielectric offers DCR-M and DCR-S models at 1/2 wavelength spacing that can cover the entire FM band for purposes of multiplexing signals. The auxiliary antenna is designed for a 4-bay or 6-bay antenna and can handle multiple signals including IBOC signals at -10 dB.

The input power can be significantly higher than our typical DCR-M models and we can feed with a 6" input. Average power ranges from 40 kW to over 120 kW are available and each system is quickly designed to meet the needs of the broadcaster and market they serve. This auxiliary antenna is designed to quickly deploy to site and give the customer flexibility. In addition the antenna design allows the installer to quickly install. In addition both the DCR-M and DCR-S is offered with heaters and radomes.

The full band operation allows broadcasters to simulcast from one antenna in emergency situations or when the main antenna is being maintained or serviced. The antenna is designed to handle the peak power of multiple signals including IBOC signals at -10 dB. The DCR-S was designed to handle more stations at a higher safety margin for multiple signals including IBOC at -10 dB. The higher peak power design should be considered. Dielectric takes pride in the safe power levels at the design stage to ensure the broadcaster has an antenna that will produce sound quality signals for many years.

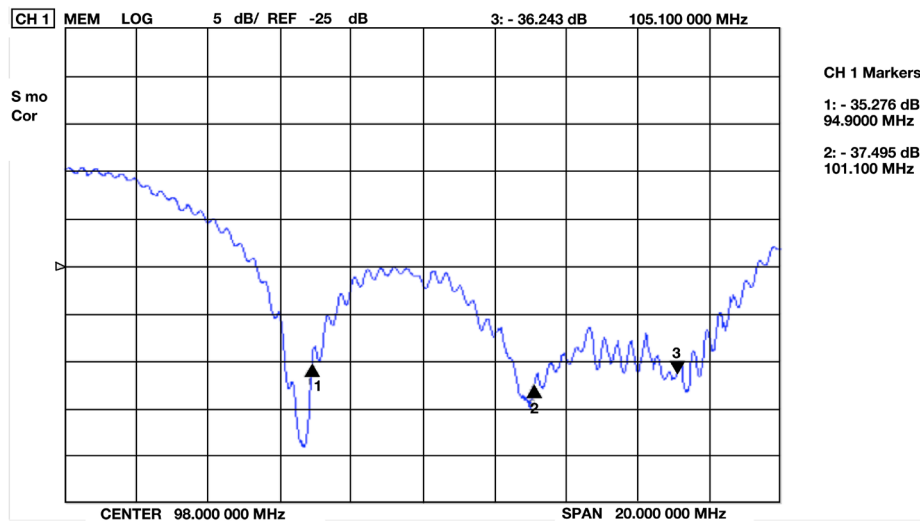

Notes:
 System VSWR or 6 bay installed system.
 Typical response for non-commercial band.
 System includes 1200' of transmission line.
 Refer to DCR-S/HDR-S (pg 16-20)
 and DCR-M/HDR-M (pg 24-28) for specifications.

Dielectric FM Achievable Bandwidths

E = END FED C- CENTER FED

	1/2 Wave Spaced	Funky Elbow	Full Wave Spaced
2E	15 MHz	7 MHz	5 MHz
2C	12 MHz	7 MHz	5 MHz
3E	15 MHz	7 MHz	5 MHz
4E	8 MHz	5 MHz	3 MHz
4C	15 MHz	7 MHz	5 MHz
5E	6 MHz	4 MHz	3 MHz
5C	15 MHz	7 MHz	5 MHz
6E	5 MHz	4 MHz	3 MHz
6C	15 MHz	7 MHz	5 MHz
8C	8 MHz	5 MHz	3 MHz
10C	15 MHz	7 MHz	5 MHz
12C	15 MHz	7 MHz	5 MHz

Notes:
 Discuss additional bandwidth considerations with Dielectric sales representative.
 Additional bandwidths available upon request.
 Refer to DCR-S/HDR-S (pg 16-20) and DCR-M/HDR-M (pg 24-28) for specifications.



DCR-E

- Ideal for Class A and B stations
- 4 kW for a single bay
- Radomes optional

The DCR-E antenna is a low-power version of the DCR-C and is available in one through twelve bays with an input power rating up to 12 kW. For situations where ice formation is common, the arrays can be equipped with radomes. The antenna is DC grounded for lightning protection and does not require shorting stubs.

End-Fed or Center-Fed Arrays

Two power distribution methods are used with the DCR-E antenna. The array is usually end-fed unless it includes beam tilt and/or null fill. In this case, the sections are fed from a center point. The input connection in either case is 1 5/8" EIA.

Beam Tilt & Null Fill

Beam tilt and/or null fill are optional extras on the DCR-E series. If optional beam tilt or null fill is specified, the antenna is designed as a center-fed array.

Directional Arrays

The DCR-E antenna is available in directional arrays which are custom-built to the needs of the station.

Low downward radiation options available – contact factory.

General Specifications

Polarization	Circular
Pattern Circularity in Free Space	± 1 dB
VSWR (max.) at Input w/o field trim	Top Mounted: 1.2:1 / Side-Mounted: 1.5:1
VSWR (max.) at Input w/ field trim, Top or Side Mounted (± 100 KHz)	1.07:1
Input	1 5/8" EIA

Mounting Dimensions

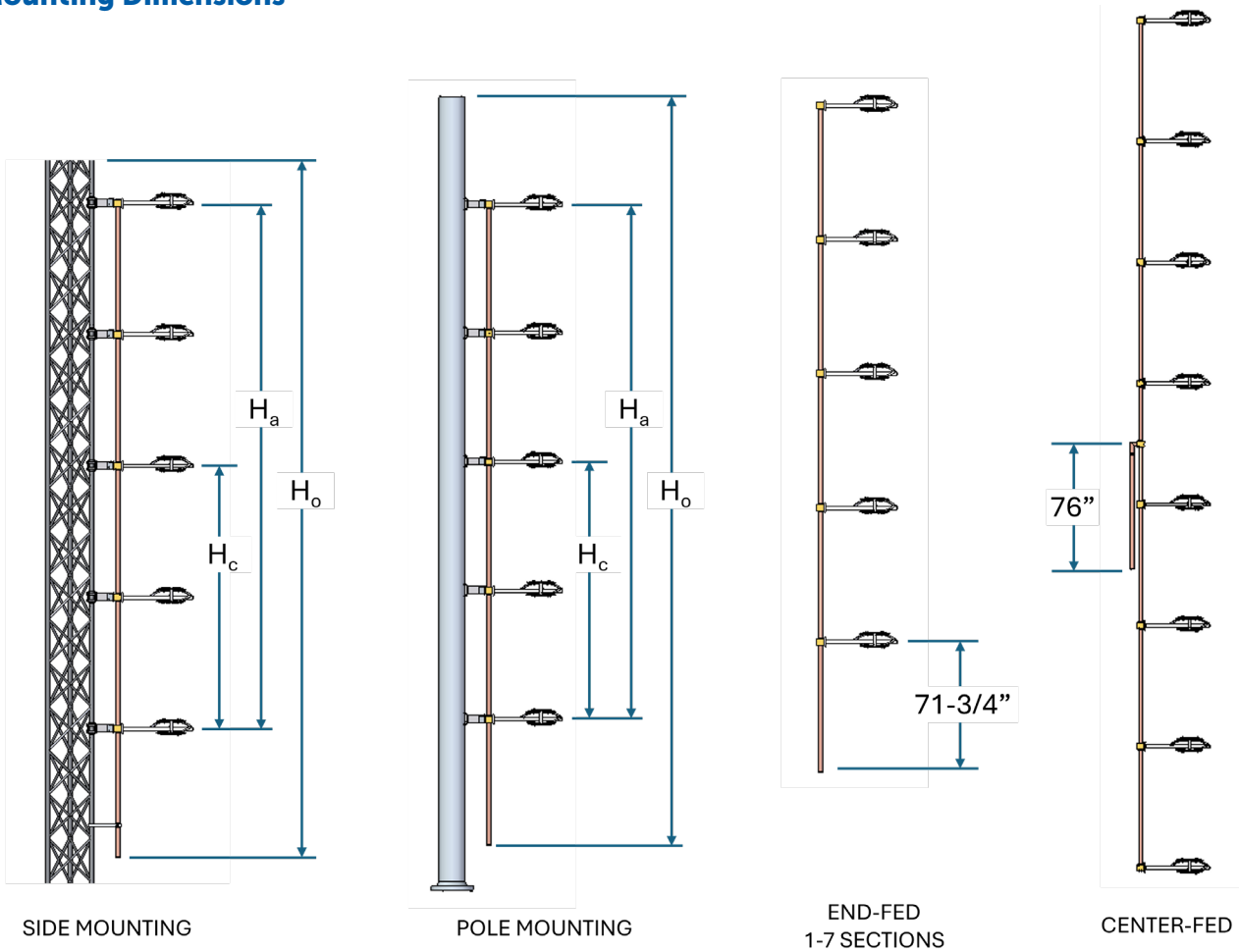

H_a = Antenna aperture length
 H_c = Antenna center of radiation
 H_o = Antenna overall length needed for mounting
 $H_a = 984/f \times [s(x-1)]$
 $H_c = H_a/2$
 $H_o \text{ end-fed} = H_a + 5'\text{top} + 10' - 5\text{'bottom}$
 $H_o \text{ center-fed} = H_a + 5'\text{top} + 5'\text{bottom}$
 All dimensions in feet
 f = frequency in megahertz (MHz)
 s = bay spacing in fraction of wavelengths
 example: $1/2$ wavelength = .5
 x = number of antenna bays

Note: Antennas ordered w/beam tilt and/or null fill are supplied with center feed and require even number of bays.

Electrical Specifications

Antenna Type DCR-H or HDR-H	Gain Polarization Spacing				Power Rating kW ³
	λ Spacing		$\frac{1}{2} \lambda$ Spacing		
	Power Gain	dB	Power Gain	dB	
DCR-E1	0.46	-3.37	—	—	4
DCR-E2	1.0	0	0.7	-1.55	8
DCR-E3	1.5	1.76	1.0	0	12
DCR-E4	2.1	3.22	1.3	1.14	12
DCR-E5	2.7	4.31	1.6	1.76	12
DCR-E6	3.2	5.05	1.8	2.55	12
DCR-E7	3.8	5.80	2.1	3.22	12
DCR-E8	4.3	6.34	2.4	3.80	12
DCR-E10	5.5	7.40	3.0	4.77	12
DCR-E12	6.6	8.2	3.6	5.56	12

Notes:

1. RMS gain data is given relative to dipole. Values are for midband and include standard harness configurations. Actual gain will vary depending on feed system, frequency, null fill, and beam tilt.
2. Average power ratings are nominal @ 40°C ambient. Assumes constant pressurization with dry air or nitrogen. Ratings may vary based on specific feed system design and local conditions.
3. Higher power ratings and custom feed systems may be available on request.
4. Antenna components and feed harnesses are optimized for FM channels of interest.
5. Specs. are for a single DCR-H antenna array, not both.

Mechanical Specifications

Without Radomes									
Antenna Type	# of Bays	Weight lbs (kg)				EPA (ft ²)			
		λ Spaced		$1/2 \lambda$ Spaced		λ Spaced		$1/2 \lambda$ Spaced	
		lbs	kg	lbs	kg	ft ²	m ²	ft ²	m ²
DCRE-1	1	54	24			3.7	0.3		
DCRE-2	2	99	45	92	42	7.5	0.7	6.7	0.6
DCRE-3	3	143	65	130	59	11.2	1	9.6	0.9
DCRE-4	4	188	85	168	76	15	1.4	12.5	1.2
DCRE-5	5	233	106	206	93	18.7	1.7	15.5	1.4
DCRE-6	6	277	126	243	110	22.5	2.1	18.4	1.7
DCRE-7	7	322	146	281	127	26.2	2.4	21.4	2
DCRE-8	8	468	212	370	168	30	2.8	24.3	2.3
DCRE-10	10	587	266	460	209	37.5	3.5	30.2	2.8
DCRE-12	12	705	320	551	250	45	4.2	36	3.3

Notes:

The 8, 10 & 12 bay antennas are center fed designs.

With Radomes

Weight lbs (kg)				EPA (ft ²)			
λ Spaced		$\frac{1}{2} \lambda$ Spaced		λ Spaced		$\frac{1}{2} \lambda$ Spaced	
lbs	kg	lbs	kg	ft ²	m ²	ft ²	m ²
84	38			4.7	0.4		
159	72	152	69	9.3	0.9	8.5	0.8
233	106	220	100	14	1.3	12.4	1.2
308	140	288	131	18.7	1.7	16.2	1.5
383	174	356	161	23.4	2.2	20.1	1.9
457	207	423	192	28	2.6	24	2.2
532	241	491	223	32.7	3	27.8	2.6
708	321	610	277	37.4	3.5	31.7	2.9
887	402	760	345	46.7	4.3	39.4	3.7
1065	483	911	413	56.1	5.2	47.1	4.4

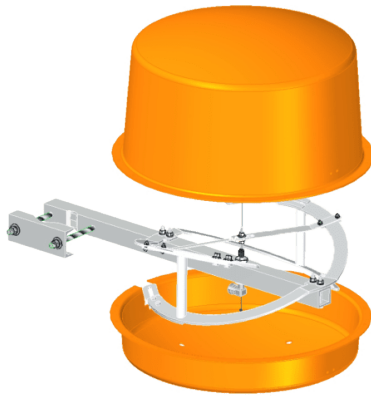

*shown with radome option

DCR-T

The DCR-T antenna is a low-power version of Dielectric’s popular DCR Series FM antennas.

Dielectric Advantages

- Circularly polarized
- Branch feed
- Band tunable
- Ideal for Class A and B stations
- IBOC compatible
- Low VSWR, <1.1:1 over operating channel (+/- 100 kHz)
- 1 kW per bay power handling
- Light weight
- Easy Installation
- All-aluminum construction
- Null fill and beam tilt available
- Bay input 7-16 DIN
- Standard array input 1 5/8" EIA
- 1- to 8-bay configurations, full- or half-wave spaced
- Available with optional radome (as shown in picture)
- Directional patterns available

Electrical Specifications

Band	Polarization	Circularity	VSWR	Input	Power Rating
FM (88-108 MHz)	Circular	± 1 dB free space	w/o field trim 1.2:1 Top Mounted 1.5:1 Side Mounted with field trim 1.07:1 (± 100 kHz)	Bay 7-16 DIN Array 1 5/8" EIA	500 W/Input

Mechanical Specifications—Individual Bay

Height ft (m)	Diameter in (m)	Weight lb (kg)	Windload ¹ ft ² (m ³)
20 (0.503)	20.7 (0.526)	17.5 (8.0)	2.4 (2.2)

¹ Wind area CAAC per TIA/EIA-222-F (CA = 1.4)

Antenna Type	# of Bays	RMS Gain Full Wave Spaced (ratio)	RMS Gain Full Wave Spaced (dBd)	RMS Gain Half Wave Spaced (ratio)	RMS Gain Half Wave Spaced (dBd)	Without Radomes		With Radomes		Power Rating kW
						Weight (lbs) λ Spaced	EPA (ft ²) λ Spaced	Weight (lbs) λ Spaced	EPA (ft ²) λ Spaced	
DCRT1	1	0.46	-3.37	0.46	-3.37	20	2.9	50	3.8	1
DCRT2	2	1	0	0.7	-1.55	50	6.2	110	8	2
DCRT3	3	1.5	1.76	1	0	72	9.1	162	11.9	3
DCRT4	4	2.1	3.22	1.2	0.79	99	13.6	219	17.3	4
DCRT5	5	2.7	4.31	1.5	1.76	124	18.4	274	23	5
DCRT6	6	3.2	5.05	1.8	2.55	150	23.8	330	29.3	6
DCRT7	7	3.8	5.8	2.1	3.22	183	29.8	373	35.5	7
DCRT8	8	4.3	6.34	2.3	3.62	212	36.5	432	43	8

Notes:

- Wind area C_AA_C is calculated per the TIA/EIA-222-G standard
- RMS gain are for midband and include feed system losses. Actual gain will vary depending on feed systems, frequency, null fill and beam tilt.
- C_AA_C include bays, power dividers, inter-bay feed lines and standard brackets for mounting.
- For more information, reference the Dielectric pattern viewer software at Dielectric.com/Software.
- Contact factory for mechanicals for antenna with radomes.

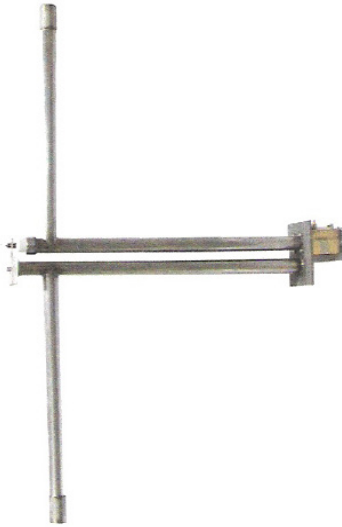

VERTICALLY POLARIZED MEDIUM POWER FM ANTENNA

- 1 kW for a single bay
- Low cost
- Low windload
- Vertical polarization
- High-power handling
- Lightweight aluminum construction
- Input power up to 40 kW
- VSWR field adjustable

The DCV antenna is designed for installations where a high-power vertical polarization antenna is desired. It has an input power rating of 5 kW per bay. It is available in stacked arrays of up to 8 sections with an input power rating of 40 kW.

The Dipole element is made of lightweight aluminum tubing with a protective coating of iridite, resulting in a strong and lightweight structure. Where required, low windload radomes are available as an option.

Power gain is proportional to the number of dipoles in the array. Each dipole provides approximately 1.0 gain (0 dB). This factor improves slightly with the number of sections in the array as well as with directional patterns. Contact the factory to determine the gain for your application.

The bandwidth of the DCV antenna allows for the use with multi-station applications. The VSWR over a 6 MHz band using a branch feed system is 1.2:1.0. The VSWR using an end fed configuration is 1.2:1.0 over a 3 MHz band.

Diplexing equipment and transmission line for multi-station systems can be provided by Dielectric allowing one supplier for all your RF requirements.

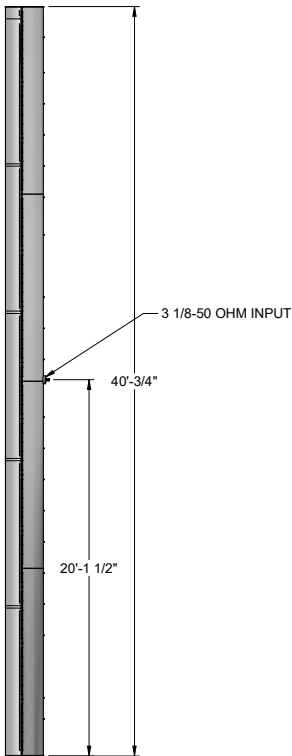

Our new Pylon Antenna changes the whole shape of FM transmission, offering broadcasters smaller size, lower wind load, higher reliability, and azimuth and elevation pattern flexibility.

Specifications

- VSWR: < 1.25 : 1 (88 MHz - 108 MHz)
- Elevation Pattern: 4-, 8-, 12-bay configurations
- Omni & cardioid azimuth patterns available as well as custom
- Maximum Average Power: 30 kW per module (4-bay)
- Standard 1° electrical beam tilt, custom upon request
- H/V ratio stability across band

Side Mount

Configuration	Max. Average Power	RMS Gain	Peak Gain
4 Bay	30 kW	4	7.48
8 Bay	60 kW	8	14.96
12 Bay	90 kW	12	22.44

Top Mount (3 Around)

4 Bay	90 kW	4	4.6 to 7.24
8 Bay	120 kW	8	9.2 to 14.48
12 Bay	180 kW	12	13.8 to 21.72

SIDE MOUNTED

OMNIROID

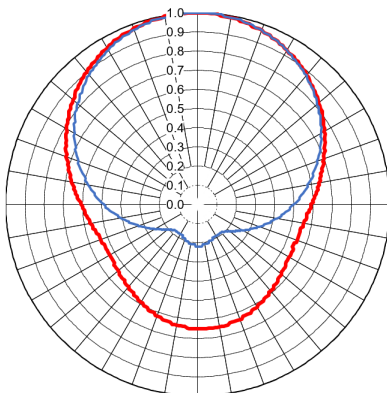

GAINS: 1.87 HPOL
2.62 VPOL

TOP MOUNTED

OMNI

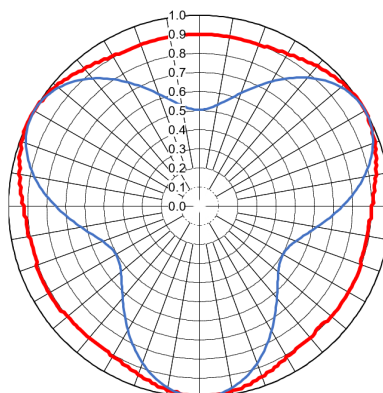

GAINS: 1.15 HPOL
1.68 VPOL

CARDIROID

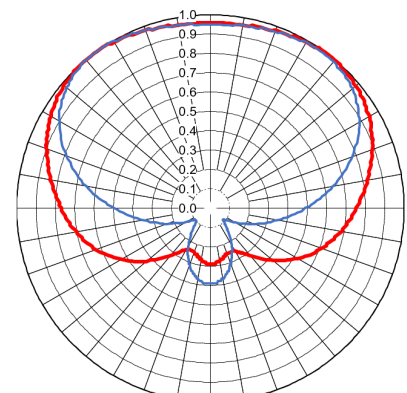

GAINS: 1.81 HPOL
2.28 VPOL

4 BAY

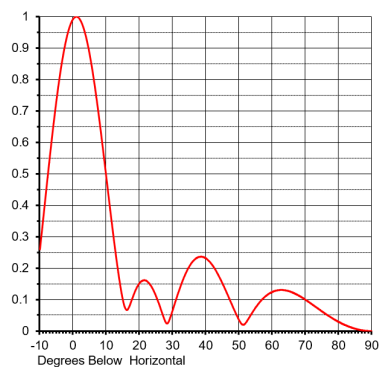
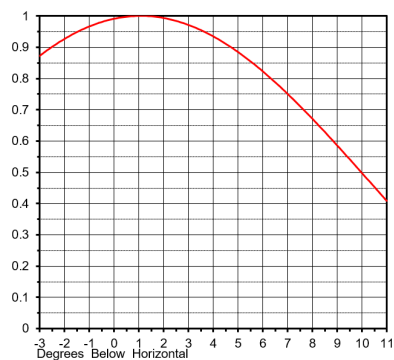

8 BAY

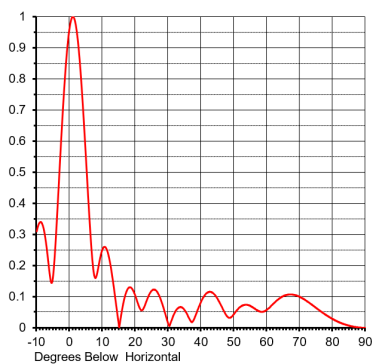
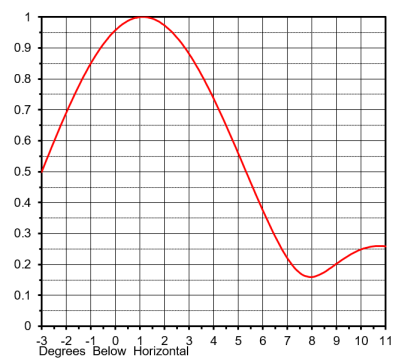

12 BAY

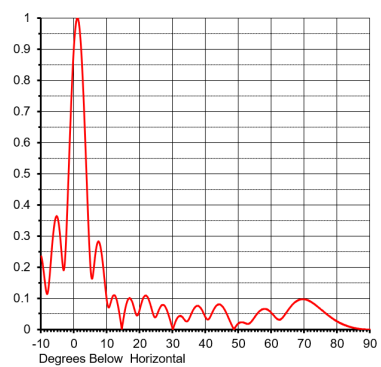
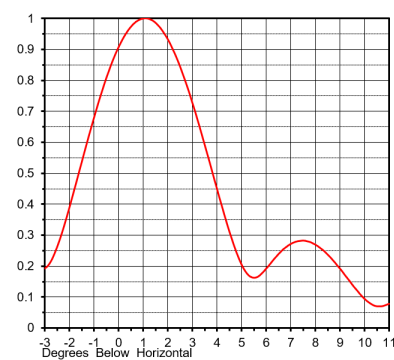



DCPJ

- Omni or directional radiation pattern
- Economic design for single station operation
- Single line or split feed arrangements
- Designed for -10 dB IBOC signals
- Single input per panel
- Fine matcher included
- Optional radomes
- Available in arrays of 1 to 12 layers
- Input: 3 1/8" 50 ohm EIA
- Multi-station options available

The DCPJ Cross Dipole FM Panel Antennas are designed to provide circularly polarized transmission for single station operation at an economical cost where optimum circularity of pattern or controlled directional characteristics are the prime requisites. The antenna is designed for face mounting, three panels per layer, around a triangular tower structure. Single or multi-layer operation is used, depending on the gain desired.

Feed System

The feed system is simple, comprised of a single 3 1/8" input with power dividers feeding each panel. The feed system is fully pressurized. Elements are at DC ground for lightning protection.

Radome Protection

For situations where ice formation is common, the elements can be equipped with optional radomes.

Gains & Power Rating

RMS gains from 0.46 (-3.37 dB) to 6.6 (8.2 dB) are available.

Options

Electrical beam tilt and null fill are available.

Accommodates Split-Feed System

The DCPJ antenna is designed to operate with a single 3 1/8" array input; however, the array may be configured to operate with two transmission lines between the array and the transmitter. In the event of failure of some array component, the inoperable half can be switched out of service and operation continued from the other half of the array at reduced ERP until the outage is corrected. Appropriate switching arrangements in the transmitter room will feed either or both portions.

Pattern Circularity

On towers of triangular cross section up to 7 1/2 foot face width, the following omnidirectional circularity values can be obtained:

- Horizontally Polarized Component: +/-2 dB average
- Vertically Polarized Component: +/-2.5 dB average

On towers of triangular cross section with an 8 to 10 foot face width, the anticipated circularity is:

- Horizontally Polarized Component: +/-2 dB average
- Vertically Polarized Component: +/-3 dB average

Tower member configuration does influence circularity. Optional scaled pattern measurements taking into account the actual tower configuration provide more precise data.

DCPJ

Input VSWR

At the input to the antenna feed system, the VSWR is 1.1:1 or better across the station channel bandwidth, and field adjustment of the variable transformer is provided.

Windloads

The antenna is designed to withstand winds of 110 mph. Under those conditions the windload on a layer of panels is shown in the table on page 50. The values were calculated as follows: Windload = Frontal Windload + (2) (Frontal Windload) (cos 60 degrees). Therefore the tabulated values do not include the effect of the tower or assume any shielding of one panel by another panel.

Weights for the various numbers of layers are also given.

Electrical Specifications

Antenna Type	# of Layers	Gain Polarization λ Spacing		Power Rating kW ³
		Power Gain	dB	
DCPJ-1	1	0.46	-3.37	10
DCPJ-2	2	1.0	0	20
DCPJ-3	3	1.5	1.76	30
DCPJ-4	4	2.1	3.22	40
DCPJ-5	5	2.7	4.31	45
DCPJ-6	6	3.3	5.19	45
DCPJ-8	8	4.4	6.43	45
DCPJ-10	10	5.5	7.40	45
DCPJ-12	12	6.6	8.20	45

Notes:

1. RMS gain data is given relative to dipole. Values are for each polarization and nominal for midband and include standard harness configurations. Actual gain will vary depending on feed system, frequency, null fill and beam tilt.
2. Average power ratings are nominal @ 40°C (104°F) ambient. Assumes constant pressurization with dry air or nitrogen. Ratings may vary based on specific feed system design and local conditions.
3. Higher power ratings and custom feed systems may be available on request.
4. Antenna components and feed harnesses are optimized for FM channels of interest

Mechanical Specifications

Antenna Type	# of Layers	Without Radomes		
		Weight lbs (kg)	Windload lbs (kg)	Projected Area ft ² (m ²)
DCPJ-1	1	925 (421)	850 (387)	17 (1.6)
DCPJ-2	2	1,700 (774)	1,700 (774)	34 (3.2)
DCPJ-3	3	2,475 (1,126)	2,550 (1,160)	51 (4.7)
DCPJ-4	4	3,365 (1,531)	3,400 (1,547)	68 (6.3)
DCPJ-5	5	4,250 (1,934)	4,250 (1,934)	85 (7.9)
DCPJ-6	6	5,180 (2,357)	5,100 (2,321)	102 (9.5)
DCPJ-8	8	6,875 (3,128)	6,800 (3,094)	136 (12.6)
DCPJ-10	10	8,620 (3,922)	8,500 (3,868)	170 (15.8)
DCPJ-12	12	10,350 (4,709)	10,200 (4,641)	204 (19.0)

Notes:

1. Weights include bays and standard extension brackets for mounting. Excludes feed system and custom mounts. For antennas that included pattern studies, contact factory for additional information.
2. Projected area excludes feed system and custom mounts.
3. Dimensions are for antennas at 98.0 MHz and can vary ±10% across the band.
4. Ice shields are strongly recommended for areas subject to tower icing. Dielectric is not responsible for antenna damage caused by impact from falling ice.
5. Area calculated expressed in terms of equivalent flats (RS-222-C standard).
6. Windload force calculated based on 50 pounds per square foot (50psf) on flats (RS-222-C standard).
7. To convert area to equivalent rounds, multiply area by 1.5.
8. To convert area to Aerodynamic area (CaAa - linear or CaAc - discrete) based on EIA-222-F standard, multiply area by 1.8.



AI-BASED FM ANTENNA PATTERN VERIFICATION

Dielectric has changed how manufacturers validate directional pattern studies for their new FM broadcast antennas, replacing the old physical process with more efficient and economical AI-driven simulated modeling.

Before Dielectric developed its innovative new modeling process, FM broadcast antenna manufacturers had to build physical models and collect measured data to verify antenna patterns – a time-consuming and burdensome process.

Dielectric’s petition proposes that the FCC allow manufacturers to transition to computer-based antenna modeling using computational methods with 3D electromagnetic solvers. This will yield results that are in many ways superior to traditional range measurement proofs. Since simulations are done in a true free-space environment, any issues with the range or anechoic chamber and surrounding environment are eliminated, resulting in more reliable azimuth patterns and H/V ratios.

The use of software also eliminates the lengthy set-up and take-down time of models, as well as the need for a technician to adjust the model and take data points by hand. This avoids mechanical tolerances and human error affecting the data. Another advantage of designing in a virtual environment is that the geometry can be completely optimized without being compromised by time, materials and tolerances.

3D electromagnetic solvers such as HFSS also add a great deal of efficiency to the measurement process, by making small changes very efficiently to completely optimize radiation patterns, without the constraints of time and material. This replaces the time-consuming trial-and-error procedures that engineers and technicians have lived with for nearly six decades.

PRE-OPTIMIZATION

Pattern exemplifies vertical component distortion caused by mounting structure.

HORIZONTAL ———

VERTICAL ———

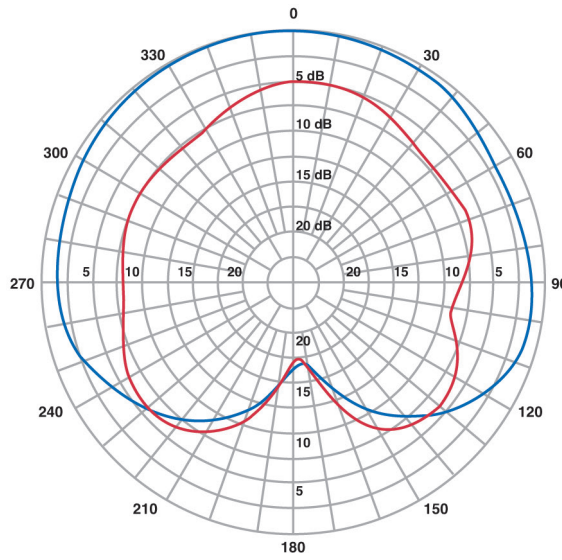

POST OPTIMIZATION

Using two parasitic elements vertical circularity has improved to near free space performance.

HORIZONTAL ———

VERTICAL ———

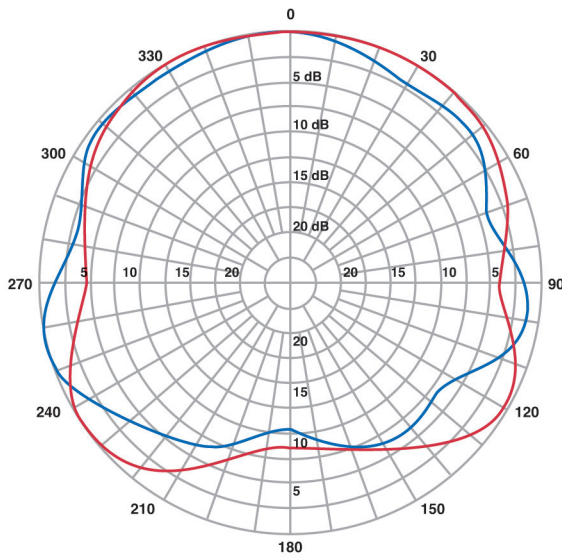

2 BAY λ

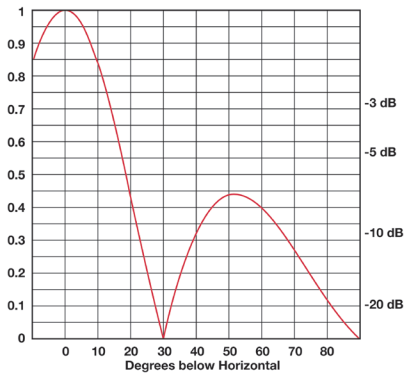

4 BAY λ

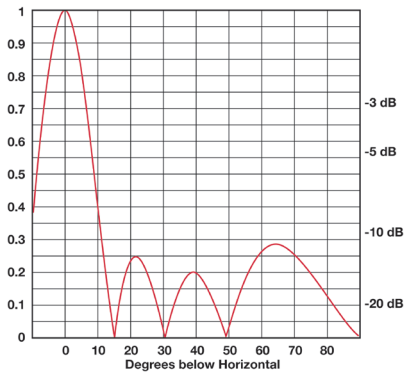

6 BAY λ

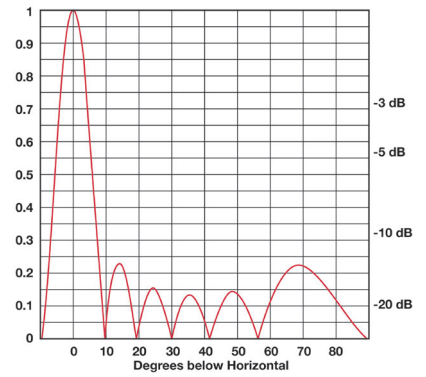

8 BAY λ

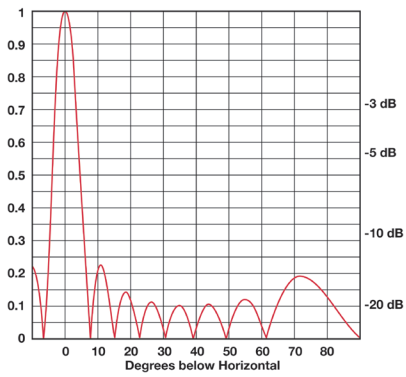

2 BAY $\lambda/2$

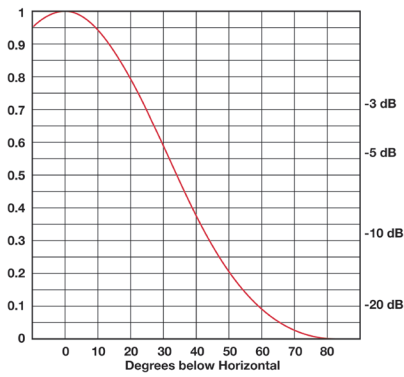

4 BAY $\lambda/2$

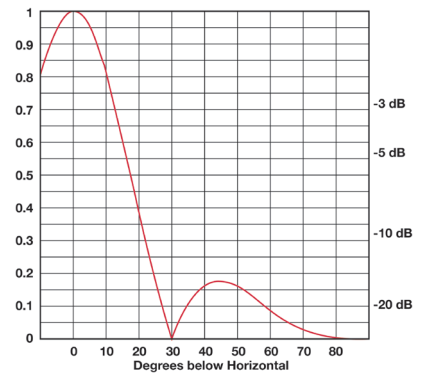

6 BAY $\lambda/2$

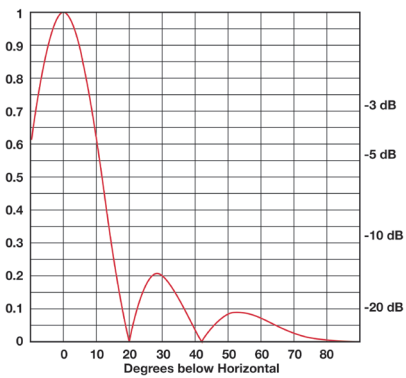

8 BAY $\lambda/2$

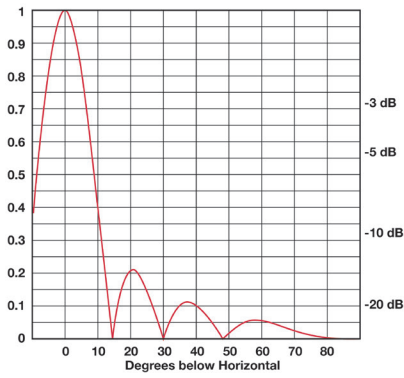

Subject to change.

Check Dielectric.com for the latest patterns and our DASP (Dielectric System Planning Software).

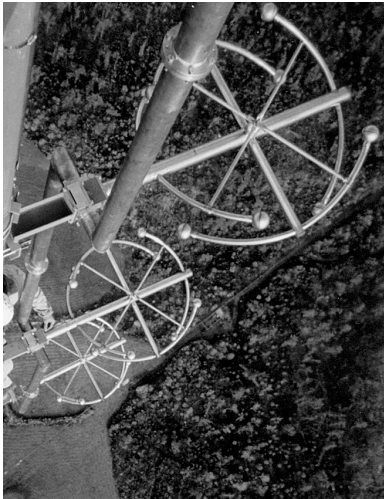

Downward radiation, or RFR, has been a concern of broadcasters for a number of years, and regulations are only getting tighter. RFR poses interference problems to neighboring electronic equipment, and exposure to non-ionizing radiation is a serious health issue. Health concerns are a particular concern near an area where people work or live.

Conscientious broadcasters strive to provide a safe environment in which people work and live. A broadcast facility is expensive and typically planned to be permanent, but it is difficult to predict what changes will occur in the surrounding community. People have increasingly chosen to locate their homes near broadcast facilities, and even though the radio station was there first, it becomes incumbent on the station to make sure it doesn't pose a hazard to neighbors or interfere with their electronics.

Good engineering therefore dictates that a substantial safety factor be included in the antenna design to avoid future problems with neighbors or ever-tightening regulations. Most Dielectric side-mounted antenna arrays can be designed with reduced bay spacing, greatly lowering the amount of downward radiation and the associated RFR concerns. Contact your Dielectric representative for additional details.



Dielectric's DCR series antennas are available in $(N-1)/N$ and $1/2$ wavelength designs to reduce RFR exposure. They offer a solution with lower weight and windloading.

HIGH-POWER BANDPASS & BANDSTOP FILTERS

- For indoor applications
- Temperature-compensated
- Retunable
- FM and FM-HD channel bandwidths compliance
- Modular design

Bandstop filters are used to suppress interference from another broadcaster that is coming down the transmitter from the antenna. These interfering signals can mix in a transmitter's high-power amplifier and generate intermodulation products that can interfere with another FM broadcaster. The notch is selected to match the transmitter power output. The filter is tuned to pass the desired channel and the notch is tuned to the interfering frequency. A dual notch can be used for close channel spacing or each notch in a dual can be tuned to two different interferers.

All Dielectric filters have been designed with HD radio in mind. The passband parameters are optimized over the complete FM channel (+/- 200 kHz).

Every unit is factory-tuned and may also be retuned in the field by the customer if desired. Dielectric's bandstop filters are modular in design. Deeper notch depth is available for wider channel suppressions.

Specifications

Model Number	DFF-140-01BS	DFF-140-02BS	DFF-240-01BS	DFF-240-01BS
Frequency	88...108 MHz	88...108 MHz	88...108 MHz	88...108 MHz
Average Power Handling ⁴	<=20 kW	<=20 kW	<=40 kW	<=40 kW
Impedance	50 Ohms	50 Ohms	50 Ohms	50 Ohms
Type	(Bandpass)	(Bandpass)	(Bandpass)	(Bandpass)
VSWR	<=1.06 dB	<=1.06 dB	<=1.06 dB	<=1.06 dB
Altitude ¹	5,000 ft (1,524 m)	5,000 ft (1,524 m)	5,000 ft (1,524 m)	5,000 ft (1,524 m)

Insertion Loss/Attenuation

F0 ²	<=0.1 dB	<=0.13 dB	<=0.1 dB	<=0.1 dB
Notch Depth Notch Spacing	>=20 dB ≥ 1.2 MHz	>=20 dB ≥ 0.8 MHz	>=30 dB ≥ 2.0 MHz	>=30 dB ≥ 0.8 MHz
Number of Cavities	1	2	1	2
Cavity Size	14"	14"	24"	24"
Group Delay Variation	<=25nS @ +/-150 Khz	<=30nS @ +/-150 Khz	<=25nS @ +/-150 Khz	<=30nS @ +/-150 Khz
Hybrids	N/A	N/A	N/A	N/A
Connectors	EIA 3 1/8" to 1 5/8"	EIA 3 1/8" to 1 5/8"	EIA 3 1/8"	EIA 3 1/8"
Blowers and Shrouds	NO	NO	NO	NO
Ambient Temperature	32°F (0°C) to 104°F (+40°C)	32°F (0°C) to 104°F (+40°C)	32°F (0°C) to 104°F (+40°C)	32°F (0°C) to 104°F (+40°C)
Storage Temperature	32°F (0°C) to 122°F (+50°C)	32°F (0°C) to 122°F (+50°C)	32°F (0°C) to 122°F (+50°C)	32°F (0°C) to 122°F (+50°C)
Ambient/Storage Humidity	0-98%, non-condensing	0-98%, non-condensing	0-98%, non-condensing	0-98%, non-condensing
Material	AL	AL	AL	AL
Dimensions (LxWxH)	15" x 15" x 46"	15" x 40" x 46"	27" x 27" x 46"	27" x 60" x 46"
Weight ³	170 lbs (77 kg)	340 lbs (154 kg)	170 lbs (77 kg)	410 lbs (186 kg)
Application	FM/FM-HD	FM/FM-HD	FM/FM-HD	FM/FM-HD

Notes:

1. For more than 5,000 ft (1,524 m), please consult factory.
2. F0 - Center Frequency
3. Estimated

POWER BANDPASS FILTER



- For indoor applications
- Temperature-compensated
- Retunable
- FM and FM-HD channel bandwidths compliance
- Modular design

FM Bandpass Filters are used as building blocks for channel combiners or as stand-alone filters to mitigate interference from nearby broadcasters. If there are several FM broadcasters on the same or nearby antennas then there may be power passed down from the antenna to a high-power transmitter. This power can mix in the output stage of the high-power amplifier and create intermodulation (IM) products. A bandpass filter will both reduce the amount of interfering power applied to a transmitter and also attenuate the resulting intermodulation product. At the frequency separation listed in the "channel separation" row the filter will have at least 40 dB of rejection. This rejection assures compliance with an -80 dB IM specification regardless of transmitter turnaround loss.

All Dielectric filters have been designed with HD radio in mind. The passband parameters are optimized over the complete FM channel (+/- 200 kHz).

Every unit is factory-tuned and may also be retuned in the field if desired. Dielectric's bandpass filters are modular in design: a three-pole filter can be changed to a four- or five-pole by simply adding cavities.

KEY FEATURES

- For indoor applications
- Temperature-compensated
- Field tunable
- FM and FM-HD channel bandwidths compliance

Model Number	FT3T6I	FT4T6I
Number of Poles	3	4
Type	Reflective (Bandpass)	Reflective (Bandpass)
Cavity Size	6"	6"
Frequency Range	88-108 MHz	88-108 MHz
Channel Spacing	≥ 2.8 MHz	≥ 1.2 MHz
Input Connectors	DIN 7/16", 7/8", EIA 1 5/8"	DIN 7/16", 7/8", EIA 1 5/8"
Average Output Power Handling ¹	≤ 2.5 kW	≤ 1.3 kW
Average Power w/ Blowers	N/A	≤ 5 kW
Output Connectors	DIN 7/16", 7/8", EIA 1 5/8"	DIN 7/16", 7/8", EIA 1 5/8"
Altitude ²	2,000 ft (609.6 m)	2,000 ft (609.6 m)
VSWR (Return Loss)	≤ 1.08:1 (≥ 28.3 dB)	≤ 1.08:1 (≥ 28.3 dB)
Impedance	50 Ω	50 Ω
Insertion Loss (Fo ³)	≤ 0.45 dB	≤ 0.75 dB
Insertion Loss ± 200 kHz	≤ 0.50 dB	≤ 0.90 dB
Group Delay	≤ 50 nsec @ +/- 150 KHz ≤ 100 nsec @ +/- 200 KHz	≤ 130 nsec @ +/- 150 KHz ≤ 310 nsec @ +/- 200 KHz
Material	AL, CU, Invar Rod	AL, CU, Invar Rod
Ambient Temperature	32° F (0° C) to 104° F (+40° C)	32° F (0° C) to 104° F (+40° C)
Storage Temperature	32° F (0° C) to 122° F (+50° C)	32° F (0° C) to 122° F (+50° C)
Ambient/Storage Humidity	0-98%, Non-condensing	0-98%, Non-condensing
Dimensions (L x W x H)	3" x 9" x 38"	37" x 9" x 38"
Weight	70 lbs	80 lbs
Application	FM/FM-HD	FM/FM-HD

Notes:

1. Free Convection Cooled
2. For more than 2,000 ft (609.6 m), please contact factory
3. Fo - Center Frequency

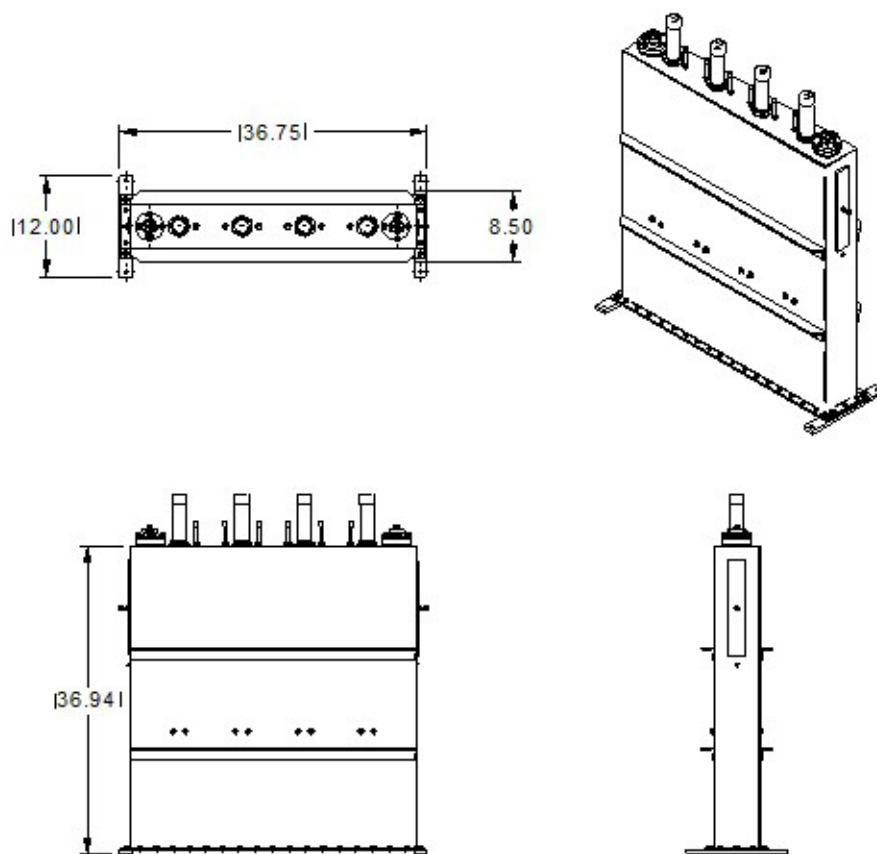
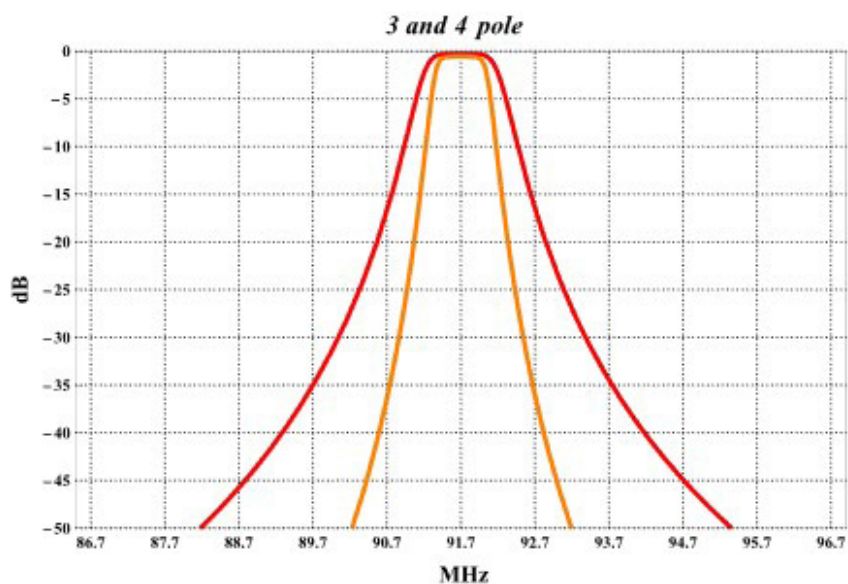

All specifications are preliminary and subject to change

KEY FEATURES

- For indoor applications
- Temperature-compensated
- Field tunable
- FM and FM-HD channel bandwidths compliance
- Modular design

Model Number	FT2T10I	FT3T10I	FT4T10I	FT5T10I
Number of Poles	2	3	4	5
Type	Reflective (Bandpass)	Reflective (Bandpass)	Reflective (Bandpass)	Reflective (Bandpass)
Cavity Size	10"	10"	10"	10"
Frequency Range	88-108 MHz	88-108 MHz	88-108 MHz	88-108 MHz
Channel Spacing	≥ 10.2 MHz	≥ 2.8 MHz	≥ 1.2 MHz	≥ 0.8 MHz
Input Connectors	EIA 1 5/8"	EIA 1 5/8"	EIA 1 5/8"	EIA 1 5/8"
Average Output Power Handling ¹	≤ 10 kW	≤ 8 kW	≤ 6 kW	≤ 4 kW
Average Power w/ Blowers	N/A	≤ 10 kW	≤ 8 kW	≤ 5 kW
Output Connectors	EIA 1 5/8", EIA 3 1/8"	EIA 1 5/8", EIA 3 1/8"	EIA 1 5/8", EIA 3 1/8"	EIA 1 5/8", EIA 3 1/8"
Altitude ²	≤ 2,000 ft (609.6 m)	≤ 2,000 ft (609.6 m)	≤ 2,000 ft (609.6 m)	≤ 2,000 ft (609.6 m)
VSWR (Return Loss)	≤ 1.06:1 (≥ 30.7 dB)	≤ 1.06:1 (≥ 30.7 dB)	≤ 1.06:1 (≥ 30.7 dB)	≤ 1.06:1 (≥ 30.7 dB)
Impedance	50 Ω	50 Ω	50 Ω	50 Ω
Insertion Loss (Fo ³)	≤ 0.35 dB	≤ 0.40 dB	≤ 0.55 dB	≤ 0.80 dB
Insertion Loss ± 200 kHz	≤ 0.35 dB	≤ 0.50 dB	≤ 0.85 dB	≤ 0.30 dB
Group Delay	≤ 20 nsec @ +/- 150 KHz ≤ 25 nsec @ +/- 200 KHz	≤ 50 nsec @ +/- 150 KHz ≤ 100 nsec @ +/- 200 KHz	≤ 130 nsec @ +/- 150 KHz ≤ 310 nsec @ +/- 200 KHz	≤ 300 nsec @ +/- 150 KHz ≤ 700 nsec @ +/- 200 KHz
Material	AL, CU, Invar Rod	AL, CU, Invar Rod	AL, CU, Invar Rod	AL, CU, Invar Rod
Ambient Temperature	32° F (0° C) to 104° F (+40° C)	32° F (0° C) to 104° F (+40° C)	32° F (0° C) to 104° F (+40° C)	32° F (0° C) to 104° F (+40° C)
Storage Temperature	32° F (0° C) to 122° F (+50° C)	32° F (0° C) to 122° F (+50° C)	32° F (0° C) to 122° F (+50° C)	32° F (0° C) to 122° F (+50° C)
Ambient/Storage Humidity	0-98%, Non-condensing	0-98%, Non-condensing	0-98%, Non-condensing	0-98%, Non-condensing
Dimensions (L x W x H)	26" x 14" x 48"	37" x 14" x 48"	48" x 14" x 48"	59" x 14" x 48"
Weight	190 lbs	255 lbs	310 lbs	375 lbs
Application	FM/FM-HD	FM/FM-HD	FM/FM-HD	FM/FM-HD

Notes:

1. Free Convection Cooled
2. For more than 2,000 ft (609.6 m), please contact factory
3. Fo - Center Frequency

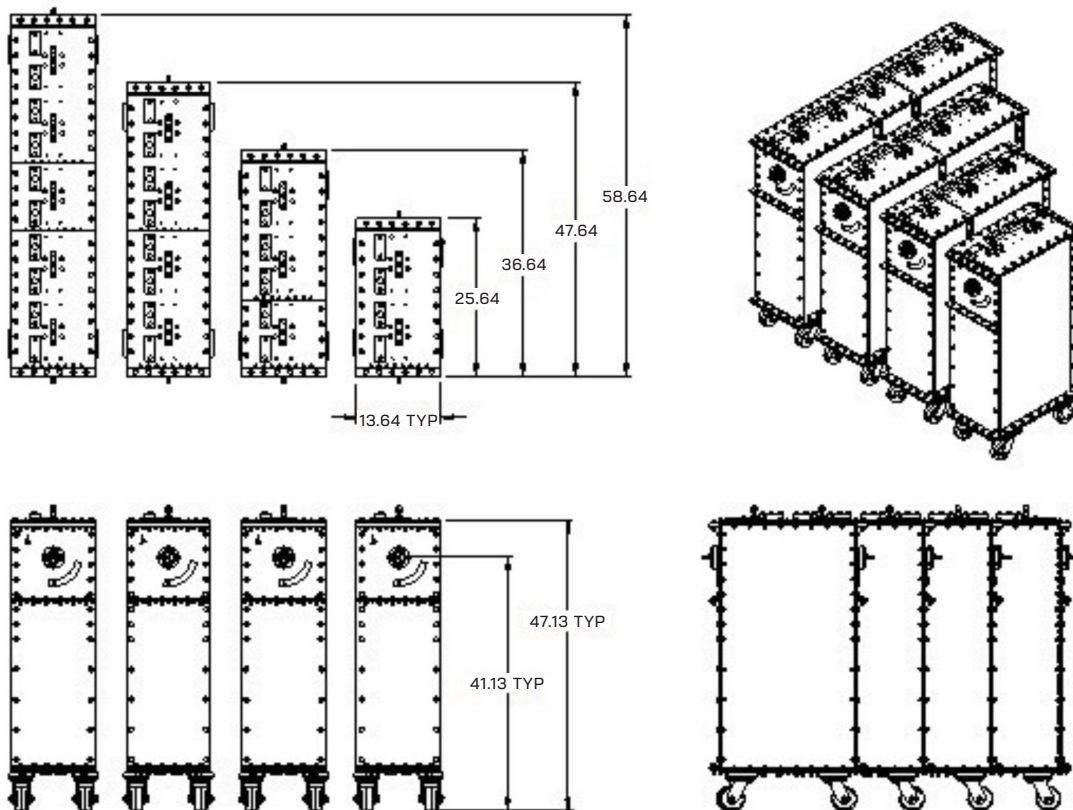
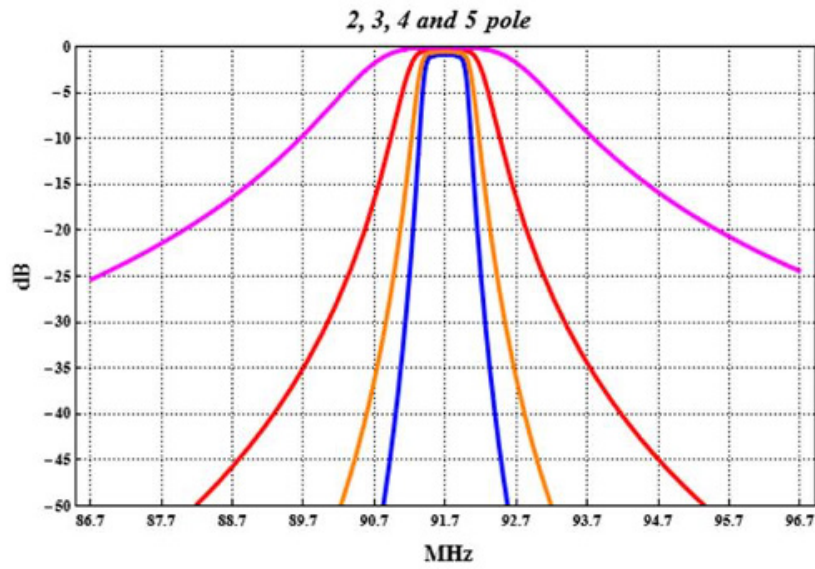

All specifications are preliminary and subject to change

KEY FEATURES

- For indoor applications
- Temperature-compensated
- Field tunable
- FM and FM-HD channel bandwidths compliance
- Modular design

Model Number	FT2T14I	FT3T14I	FT4T14I	FT5T14I
Number of Poles	2	3	4	5
Type	Reflective (Bandpass)	Reflective (Bandpass)	Reflective (Bandpass)	Reflective (Bandpass)
Cavity Size	14"	14"	14"	14"
Frequency Range	88-108 MHz	88-108 MHz	88-108 MHz	88-108 MHz
Channel Spacing	≥ 10.2 MHz	≥ 2.8 MHz	≥ 1.2 MHz	≥ 0.8 MHz
Input Connectors	EIA 1 5/8", EIA 3 1/8"	EIA 1 5/8", EIA 3 1/8"	EIA 1 5/8", EIA 3 1/8"	EIA 1 5/8", EIA 3 1/8"
Average Output Power Handling ^{1, 4}	≤ 18 kW	≤ 16 kW	≤ 13 kW	≤ 10 kW
Average Power w/ Blowers	≤ 23 kW	≤ 20 kW	≤ 18 kW	≤ 15 kW
Output Connectors	EIA 1 5/8", EIA 3 1/8", EIA 6 1/8"	EIA 1 5/8", EIA 3 1/8", EIA 6 1/8"	EIA 1 5/8", EIA 3 1/8", EIA 6 1/8"	EIA 1 5/8", EIA 3 1/8", EIA 6 1/8"
Altitude ²	≤ 2,000 ft (609.6 m)	≤ 2,000 ft (609.6 m)	≤ 2,000 ft (609.6 m)	≤ 2,000 ft (609.6 m)
VSWR (Return Loss)	≤ 1.06:1 (≥ 30.7 dB)	≤ 1.06:1 (≥ 30.7 dB)	≤ 1.06:1 (≥ 30.7 dB)	≤ 1.06:1 (≥ 30.7 dB)
Impedance	50 Ω	50 Ω	50 Ω	50 Ω
Insertion Loss (Fo ³)	≤ 0.20 dB	≤ 0.20 dB	≤ 0.40 dB	≤ 0.45 dB
Insertion Loss ± 200 kHz	≤ 0.25 dB	≤ 0.35 dB	≤ 0.60 dB	≤ 0.65 dB
Group Delay	≤ 20 nsec @ +/- 150 KHz ≤ 25 nsec @ +/- 200 KHz	≤ 50 nsec @ +/- 150 KHz ≤ 100 nsec @ +/- 200 KHz	≤ 130 nsec @ +/- 150 KHz ≤ 310 nsec @ +/- 200 KHz	≤ 300 nsec @ +/- 150 KHz ≤ 700 nsec @ +/- 200 KHz
Material	AL, CU, Invar Rod	AL, CU, Invar Rod	AL, CU, Invar Rod	AL, CU, Invar Rod
Ambient Temperature	32° F (0° C) to 104° F (+40° C)	32° F (0° C) to 104° F (+40° C)	32° F (0° C) to 104° F (+40° C)	32° F (0° C) to 104° F (+40° C)
Storage Temperature	32° F (0° C) to 122° F (+50° C)	32° F (0° C) to 122° F (+50° C)	32° F (0° C) to 122° F (+50° C)	32° F (0° C) to 122° F (+50° C)
Ambient/Storage Humidity	0-98%, Non-condensing	0-98%, Non-condensing	0-98%, Non-condensing	0-98%, Non-condensing
Dimensions (L x W x H)	34" x 18" x 48"	49" x 18" x 48"	64" x 18" x 48"	79" x 18" x 48"
Weight	240 lbs	325 lbs	400 lbs	480 lbs
Application	FM/FM-HD	FM/FM-HD	FM/FM-HD	FM/FM-HD

Notes:

1. Free Convection Cooled
2. For more than 2,000 ft (609.6 m), please contact factory
3. Fo - Center Frequency
4. Power handling rating for 1 5/8" input for 2, 3 and 4 pole filters limited to ≤ 12 kW

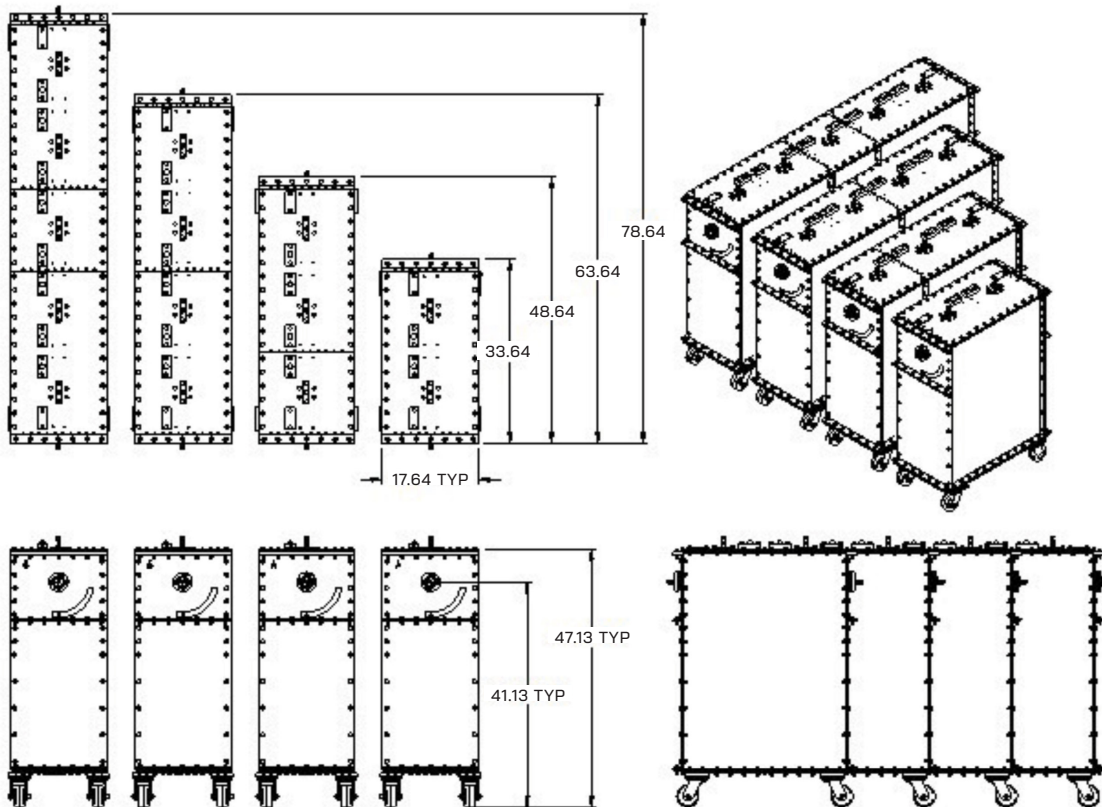
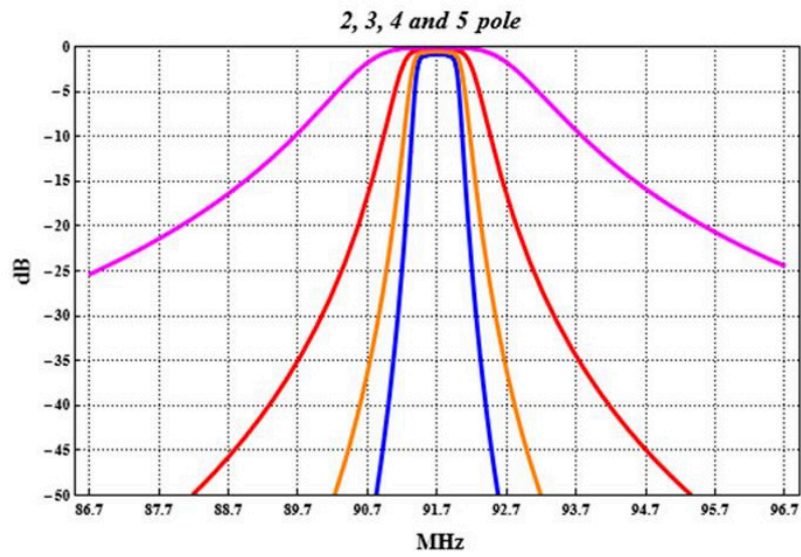

All specifications are preliminary and subject to change

KEY FEATURES

- For indoor applications
- Temperature-compensated
- Field tunable
- FM and FM-HD channel bandwidths compliance
- Modular design

Model Number	FT2T14I	FT3T14I	FT4T14I	FT5T14I
Number of Poles	2	3	4	5
Type	Reflective (Bandpass)	Reflective (Bandpass)	Reflective (Bandpass)	Reflective (Bandpass)
Cavity Size	21"	21"	21"	21"
Frequency Range	88-108 MHz	88-108 MHz	88-108 MHz	88-108 MHz
Channel Spacing	≥ 10.2 MHz	≥ 2.8 MHz	≥ 1.2 MHz	≥ 0.8 MHz
Input Connectors	EIA 3 1/8", EIA 6 1/8"	EIA 3 1/8", EIA 6 1/8"	EIA 3 1/8", EIA 6 1/8"	EIA 3 1/8", EIA 6 1/8"
Average Output Power Handling ^{1, 4}	≤ 35 kW	≤ 28 kW	≤ 23 kW	≤ 20 kW
Average Power w/ Blowers	≤ 45 kW	≤ 38 kW	≤ 33 kW	≤ 30 kW
Output Connectors	EIA 3 1/8", 6 1/8"	EIA 3 1/8", 6 1/8"	EIA 3 1/8", 6 1/8"	EIA 3 1/8", 6 1/8"
Altitude ²	≤ 2,000 ft (609.6 m)	≤ 2,000 ft (609.6 m)	≤ 2,000 ft (609.6 m)	≤ 2,000 ft (609.6 m)
VSWR (Return Loss)	≤ 1.06:1 (≥ 30.7 dB)	≤ 1.06:1 (≥ 30.7 dB)	≤ 1.06:1 (≥ 30.7 dB)	≤ 1.06:1 (≥ 30.7 dB)
Impedance	50 Ω	50 Ω	50 Ω	50 Ω
Insertion Loss (Fo ³)	≤ 0.10 dB	≤ 0.20 dB	≤ 0.30 dB	≤ 0.40 dB
Insertion Loss ± 200 kHz	≤ 0.15 dB	≤ 0.25 dB	≤ 0.45 dB	≤ 0.65 dB
Group Delay	≤ 20 nsec @ +/- 150 KHz ≤ 25 nsec @ +/- 200 KHz	≤ 50 nsec @ +/- 150 KHz ≤ 100 nsec @ +/- 200 KHz	≤ 130 nsec @ +/- 150 KHz ≤ 310 nsec @ +/- 200 KHz	≤ 300 nsec @ +/- 150 KHz ≤ 700 nsec @ +/- 200 KHz
Material	AL, CU, Invar Rod	AL, CU, Invar Rod	AL, CU, Invar Rod	AL, CU, Invar Rod
Ambient Temperature	32° F (0° C) to 104° F (+40° C)	32° F (0° C) to 104° F (+40° C)	32° F (0° C) to 104° F (+40° C)	32° F (0° C) to 104° F (+40° C)
Storage Temperature	32° F (0° C) to 122° F (+50° C)	32° F (0° C) to 122° F (+50° C)	32° F (0° C) to 122° F (+50° C)	32° F (0° C) to 122° F (+50° C)
Ambient/Storage Humidity	0-98%, Non-condensing	0-98%, Non-condensing	0-98%, Non-condensing	0-98%, Non-condensing
Dimensions (L x W x H)	58" x 25" x 50"	84" x 25" x 50"	111" x 25" x 50"	138" x 25" x 50"
Weight	360 lbs	488 lbs	650 lbs	790 lbs
Application	FM/FM-HD	FM/FM-HD	FM/FM-HD	FM/FM-HD

Notes:

1. Free Convection Cooled
2. For more than 2,000 ft (609.6 m), please contact factory
3. Fo - Center Frequency

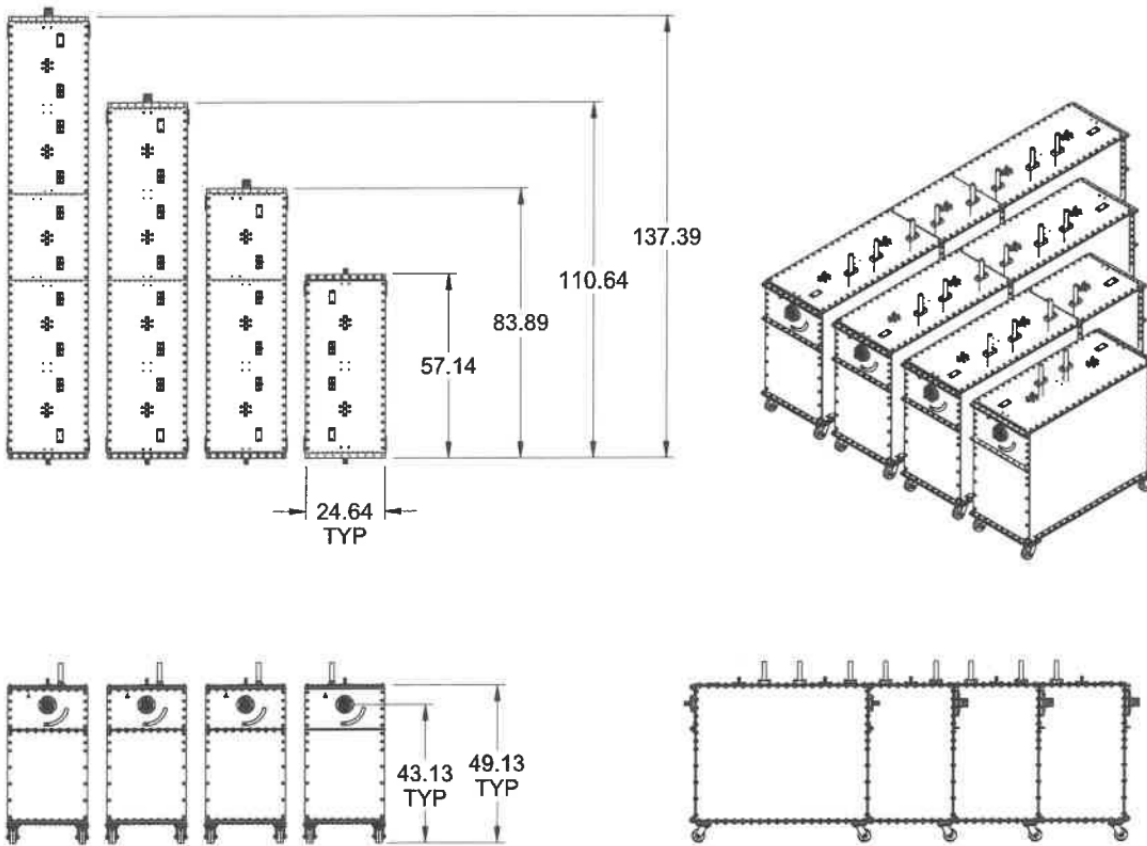
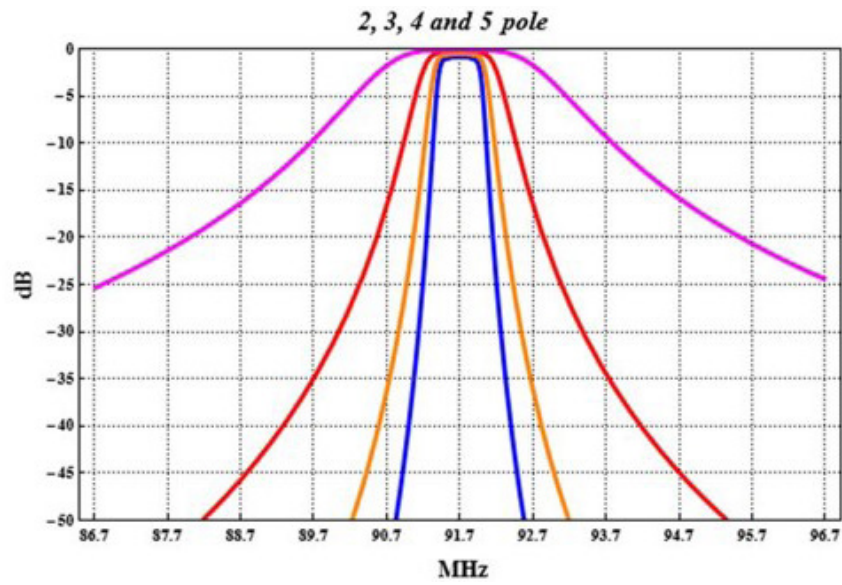

All specifications are preliminary and subject to change

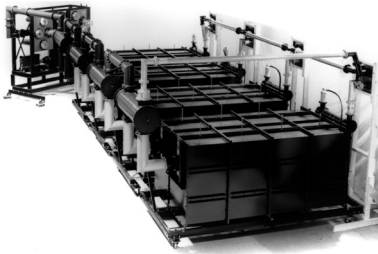

General Description

FM transmitters operating on different frequencies often share a common antenna using a combiner, whose primary function is to combine each high-power signal with low loss and maintain high isolation between the transmitters. A second function is to assure that the spurious and intermodulation products generated by combined transmitters are attenuated below the level required by the FCC (part 73), which states any emission greater than 600 kHz from the carrier be at least -80 dB below the carrier. If the turn-around loss of the transmitters is known, Dielectric will supply a combiner, ensuring compliance with the FCC requirements. All Dielectric filters are tuned with HD radio in mind. The full channel bandwidth ($f_c \pm 200$ kHz) has excellent match and minimized insertion loss/group delay.

A branch combiner is an effective and economical way to combine two or three transmitters onto a single line. This approach uses a single band-pass filter for each channel and "tees" the power together at the output end. A branch combiner can be used for channel spacing as small as 800 kHz.

A manifold combiner is recommended as an economical solution for combining three to ten channels. This approach is similar to the branch combiner in that there is one filter per channel. The manifold can be used for channel spacing as small as 800 kHz.

The constant impedance combiner is a standard FM combining approach. This approach has excellent power handling, very high isolations, and the ability to add channels in the future. A constant impedance module consists of two band-pass filters, two 3 dB hybrids and a reject load that can be chained together to combine ten or more stations into a single antenna.

LOW-POWER BANDPASS COMMON CASE COMBINING

KEY FEATURES

- Tee junction and delay lines eliminated
- Higher efficiency, lower operating cost
- IBOC compatible
- Field-tunable 3 or 4 pole designs
- Cross coupling optional for tighter isolation and efficiency
- Compact for space-limited sites

Model Number	FT3T6I-CC	FT4T6I-CC
Number of Poles	3	4
Type	Reflective (Bandpass)	Reflective (Bandpass)
Cavity Size	6"	6"
Frequency Range	88-108 MHz	88-108 MHz
Channel Spacing	≥ 2.8 MHz	≥ 1.2 MHz
Input Connectors	DIN 7/16, 7/8", EIA 1 5/8"	DIN 7/16, 7/8", EIA 1 5/8"
Average Output Power Handling ¹	≤ 3.0 kW	≤ 1.5 kW
Average Power w/ Blowers	N/A	N/A
Output Connectors	DIN 7/16, 7/8", EIA 1 5/8"	DIN 7/16, 7/8", EIA 1 5/8"
Altitude ²	≤ 2,000 ft (609.6 m)	≤ 2,000 ft (609.6 m)
VSWR (Return Loss)	≤ 1.08:1 (≥ 28.3 dB)	≤ 1.08:1 (≥ 28.3 dB)
Impedance	50 Ω	50 Ω
Insertion Loss (Fo ³)	≤ 0.45 dB	≤ 0.75 dB
Insertion Loss ± 200 kHz	≤ 0.50 dB	≤ 0.50 dB
Group Delay	≤ 50 nsec @ +/- 150 KHz ≤ 100 nsec @ +/- 200 KHz	≤ 130 nsec @ +/- 150 KHz ≤ 310 nsec @ +/- 200 KHz
Material	AL, CU, Invar Rod	AL, CU, Invar Rod
Ambient Temperature	32° F (0° C) to 104° F (+40° C)	32° F (0° C) to 104° F (+40° C)
Storage Temperature	32° F (0° C) to 122° F (+50° C)	32° F (0° C) to 122° F (+50° C)
Ambient/Storage Humidity	0-98%, Non-condensing	0-98%, Non-condensing
Dimensions (L x W x H)	32" x 13" x 40"	39" x 13" x 40"
Weight	120 lbs	150 lbs
Application	FM/FM-HD	FM/FM-HD

Notes:

1. Free Convection Cooled
2. For more than 2,000 ft (609.6 m), please contact factory
3. Fo - Center Frequency

LOW-POWER BANDPASS COMMON CASE COMBINING

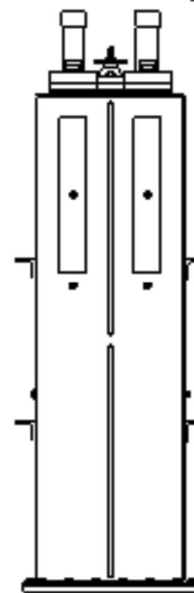
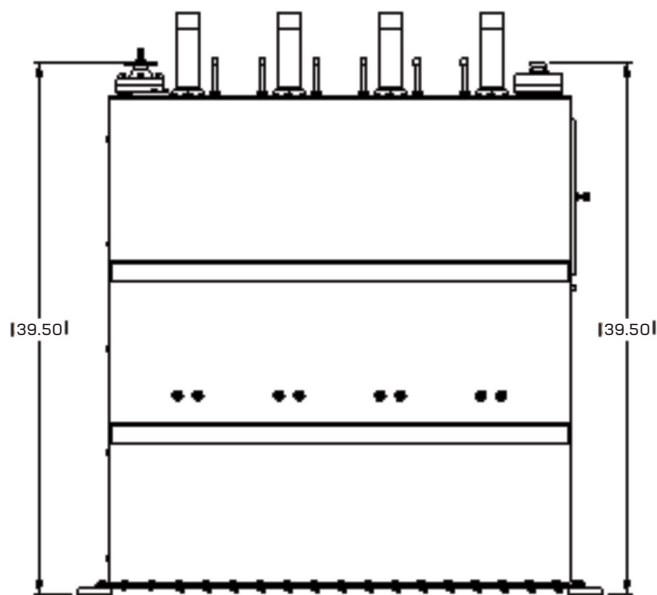
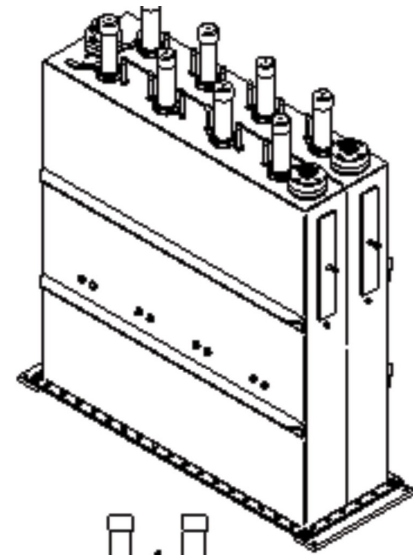
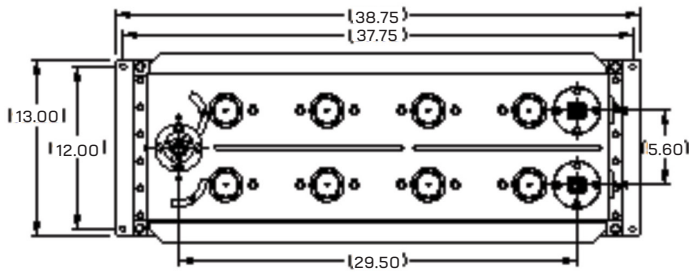
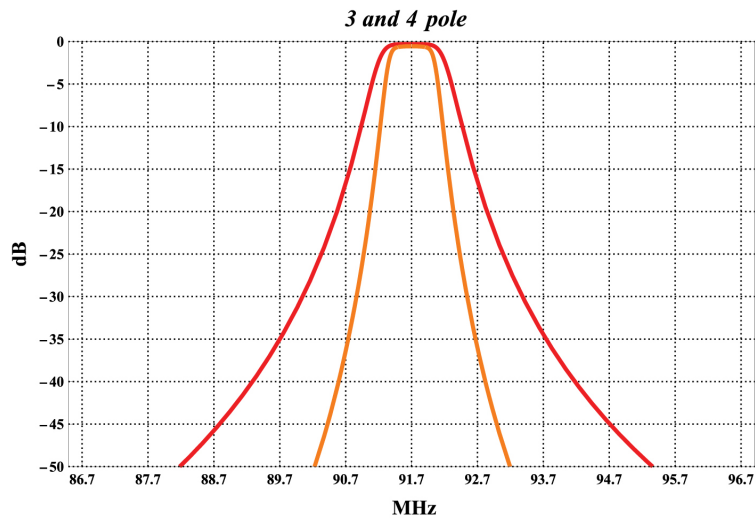

All specifications are preliminary and subject to change

LOW/MEDIUM-POWER BANDPASS COMMON CASE COMBINING

KEY FEATURES

- Tee junction and delay lines eliminated
- Higher efficiency, lower operating cost
- IBOC compatible
- Field-tunable 3 or 4 pole designs
- Cross coupling optional for tighter isolation and efficiency
- Compact for space-limited sites

Model Number	FT3T10I-CC	FT4T10I-CC
Number of Poles	3	4
Type	Reflective (Bandpass)	Reflective (Bandpass)
Cavity Size	10"	10"
Frequency Range	88-108 MHz	88-108 MHz
Channel Spacing	≥ 2.8 MHz	≥ 1.2 MHz
Input Connectors	EIA 1 5/8"	EIA 1 5/8"
Average Output Power Handling ¹	≤ 12 kW	≤ 9 kW
Average Power w/ Blowers	N/A	≤ 11 kW
Output Connectors	EIA 1 5/8"	EIA 1 5/8"
Altitude ²	≤ 2,000 ft (609.6 m)	≤ 2,000 ft (609.6 m)
VSWR (Return Loss)	≤ 1.08:1 (≥ 28.3 dB)	≤ 1.08:1 (≥ 28.3 dB)
Impedance	50 Ω	50 Ω
Insertion Loss (Fo ³)	≤ 0.40 dB	≤ 0.55 dB
Group Delay	≤ 50 nsec @ +/- 150 KHz ≤ 100 nsec @ +/- 200 KHz	≤ 130 nsec @ +/- 150 KHz ≤ 310 nsec @ +/- 200 KHz
Material	AL, CU, Invar Rod	AL, CU, Invar Rod
Ambient Temperature	32° F (0° C) to 104° F (+40° C)	32° F (0° C) to 104° F (+40° C)
Storage Temperature	32° F (0° C) to 122° F (+50° C)	32° F (0° C) to 122° F (+50° C)
Ambient/Storage Humidity	0-98%, Non-condensing	0-98%, Non-condensing
Dimensions (L x W x H)	37" x 25" x 48"	48" x 25" x 48"
Weight	250 lbs	325 lbs
Application	FM/FM-HD	FM/FM-HD

Notes:

1. Free Convection Cooled
2. For more than 2,000 ft (609.6 m), please contact factory
3. Fo - Center Frequency

LOW/MEDIUM-POWER BANDPASS COMMON CASE COMBINING

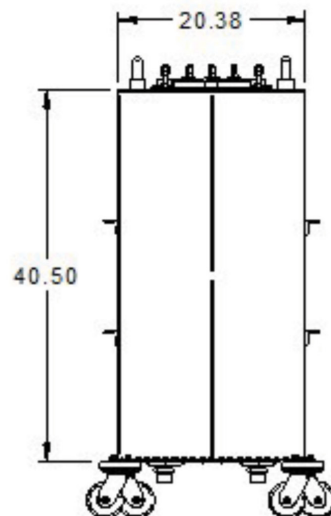
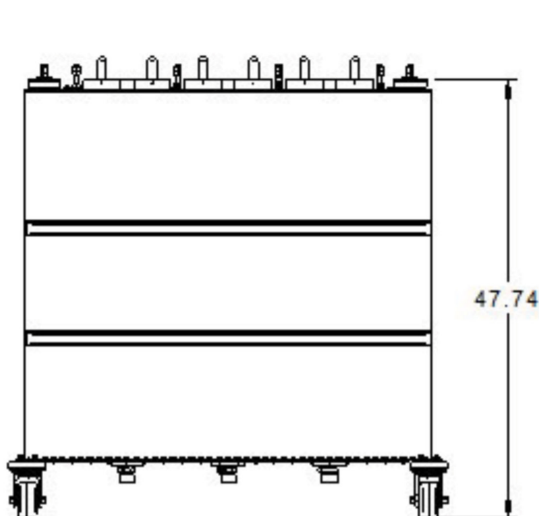
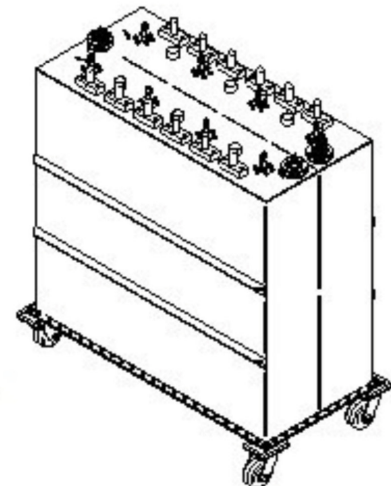
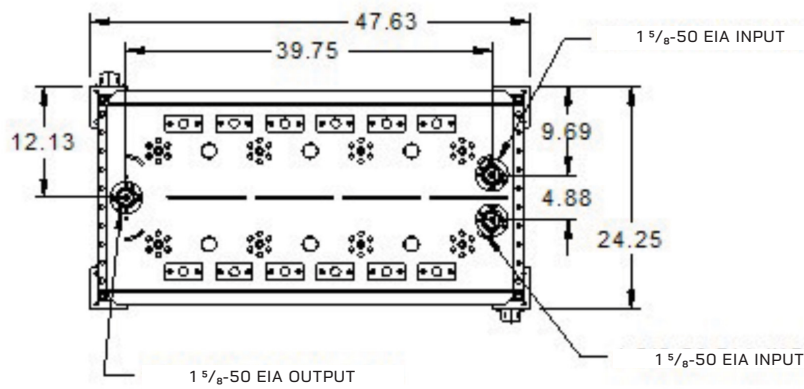
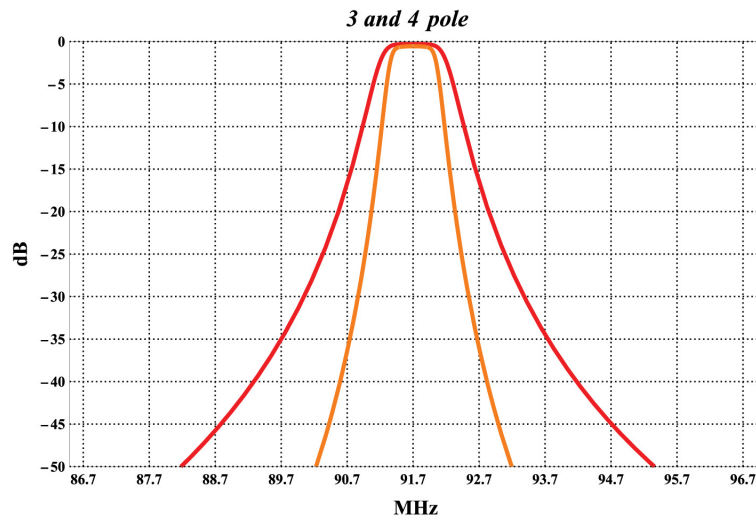

All specifications are preliminary and subject to change

2 CHANNEL (MEDIUM POWER)

- For indoor applications
- Temperature-compensated
- High isolation
- FM and FM-HD channel bandwidths compliance
- Modular design

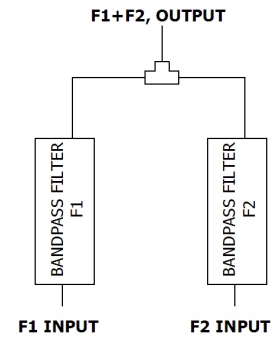
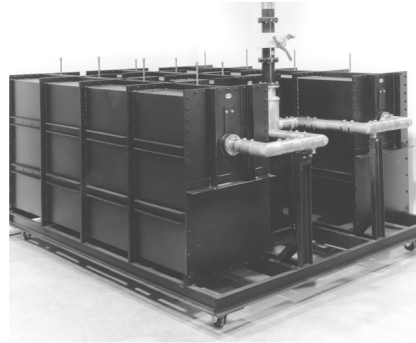

Specifications

Model Number	DFC14002BR2	DFC14003BR2	DFC14004BR2	DFC14005BR2
Frequency	87.5...108 MHz	87.5...108 MHz	87.5...108 MHz	87.5...108 MHz
Combiner Type	Branch Combiner	Branch Combiner	Branch Combiner	Branch Combiner
Channel Spacing	>=10.2 MHz	>=2.8 MHz	>=1.2 MHz	>=0.8 MHz

Narrow Band Input

Average Power Handling	25 kW (per Input)	20 kW (per Input)	15 kW (per Input)	12 kW (per Input)
Average Power w/ Blowers	30 kW (per Input)	25 kW (per Input)	20 kW (per Input)	17 kW (per Input)
Temperature-compensated	YES	YES	YES	YES

Insertion Loss

F0 ¹	<=0.15 dB	<=0.25 dB	<=0.35 dB	<=0.45 dB
VSWR	<=1.06	<=1.06	<=1.06	<=1.06
Group Delay Variation	<=30nS @ +/-150 KHz	<=50nS @ +/-150 KHz	<=70nS @ +/-150 KHz	<=160nS @ +/-150 KHz
Number of Cavities	2	3	4	5
Cavity Size	14"	14"	14"	14"
Input Connector	EIA 3 1/8"	EIA 3 1/8"	EIA 3 1/8"	EIA 3 1/8"
Output Connector	EIA 3 1/8"	EIA 3 1/8"	EIA 3 1/8"	EIA 3 1/8"
Isolation Between Inputs	>=35 dB	>=35 dB	>=35 dB	>=35 dB
Material	AL+Cu Resonators +INVAR Roads	AL+Cu Resonators +INVAR Roads	AL+Cu Resonators +INVAR Roads	AL+Cu Resonators +INVAR Roads
Ambient Temperature	32°F (0°C) to 104°F (+40°C)	32°F (0°C) to 104°F (+40°C)	32°F (0°C) to 104°F (+40°C)	32°F (0°C) to 104°F (+40°C)
Storage Temperature	32°F (0°C) to 122°F (+50°C)	32°F (0°C) to 122°F (+50°C)	32°F (0°C) to 104°F (+50°C)	32°F (0°C) to 122°F (+50°C)
Dimensions (LxWxH)	48" x 28" x 57" (1219 mm x 711 mm x 1448 mm)	72" x 28" x 57" (1,829 mm x 711 mm x 1,448 mm)	96" x 28" x 57" (2,439 mm x 711 mm x 1,448 mm)	120" x 28" x 57" (3,048 mm x 711 mm x 1,448 mm)
Weight ³	360 lbs (164 kg)	545 lbs (247 kg)	723 lbs (328 kg)	900 lbs (408 kg)
Altitude ⁴	5,000 ft (1,524 m)	5,000 ft (1,524 m)	5,000 ft (1,524 m)	5,000 ft (1,524 m)
Application	FM/FM-HD	FM/FM-HD	FM/FM-HD	FM/FM-HD

Notes:

1. F0 - Center Frequency
2. Estimated
3. For more than 5,000 ft (1,524 m), please consult the factory

2 CHANNEL (HIGH-POWER)

- For indoor applications
- Temperature-compensated
- High isolation
- FM and FM-HD channel bandwidths compliance
- Modular design

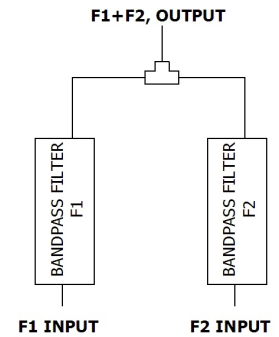
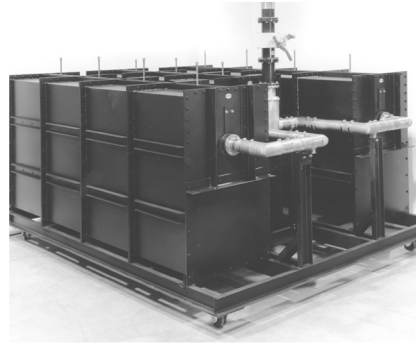

Specifications

Model Number	DFC24002BR2	DFC24003BR2	DFC24004BR2	DFC24005BR2
Frequency	87.5...108 MHz	87.5...108 MHz	87.5...108 MHz	87.5...108 MHz
Combiner Type	Branch Combiner	Branch Combiner	Branch Combiner	Branch Combiner
Channel Spacing	>=10.2 MHz	>=2.8 MHz	>=1.2 MHz	>=0.8 MHz

Narrow Band Input

Average Power Handling	35 kW (per Input)	28 kW (per Input)	23 kW (per Input)	20 kW (per Input)
Average Power w/ Blowers	45 kW (per Input)	38 kW (per Input)	33 kW (per Input)	30 kW (per Input)
Temperature-compensated	YES	YES	YES	YES

Insertion Loss

F0'	<=0.10 dB	<=0.15 dB	<=0.25 dB	<=0.35 dB
VSWR	<=1.06	<=1.06	<=1.06	<=1.06
Group Delay Variation	<=30nS @ +/-150 KHz	<=50nS @ +/-150 KHz	<=70nS @ +/-150 KHz	<=160nS @ +/-150 KHz
Number of Cavities	2	3	4	5
Cavity Size	24"	24"	24"	24"
Input Connector	EIA 3 1/8"	EIA 3 1/8"	EIA 3 1/8"	EIA 3 1/8"
Output Connector	EIA 6 1/8"	EIA 6 1/8"	EIA 6 1/8"	EIA 6 1/8"
Isolation Between Inputs	>=35 dB	>=35 dB	>=35 dB	>=35 dB
Material	AL+Cu Resonators +INVAR Roads	AL+Cu Resonators +INVAR Roads	AL+Cu Resonators +INVAR Roads	AL+Cu Resonators +INVAR Roads
Ambient Temperature	32°F (0°C) to 104°F (+40°C)	32°F (0°C) to 104°F (+40°C)	32°F (0°C) to 104°F (+40°C)	32°F (0°C) to 104°F (+40°C)
Storage Temperature	32°F (0°C) to 122°F (+50°C)	32°F (0°C) to 122°F (+50°C)	32°F (0°C) to 122°F (+50°C)	32°F (0°C) to 122°F (+50°C)
Dimensions (LxWxH)	55" x 66" x 57" (1,397 mm x 1,677 mm x 1,448 mm)	79" x 66" x 57" (2,007 mm x 1,677 mm x 1,448 mm)	103" x 66" x 57" (1,616 mm x 1,677 mm x 1,448 mm)	127" x 66" x 57" (3,226 mm x 1,677 mm x 1,448 mm)
Weight ³	740 lbs (336 kg)	1,110 lbs (504 kg)	1,466 lbs (665 kg)	1,820 lbs (826 kg)
Altitude ⁴	5,000 ft (1,524 m)	5,000 ft (1,524 m)	5,000 ft (1,524 m)	5,000 ft (1,524 m)
Application	FM/FM-HD	FM/FM-HD	FM/FM-HD	FM/FM-HD

Notes:

1. F0 - Center Frequency
2. Estimated
3. For more than 5,000 ft (1,524 m), please consult the factory

3 CHANNEL

- For indoor applications
- Temperature-compensated
- High isolation
- FM and FM-HD channel bandwidths compliance
- Modular design

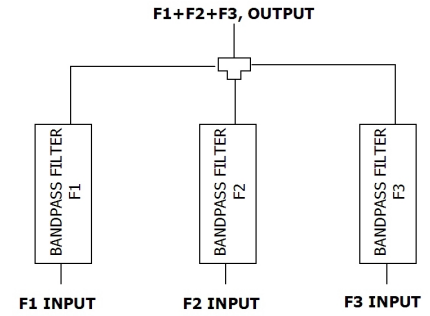
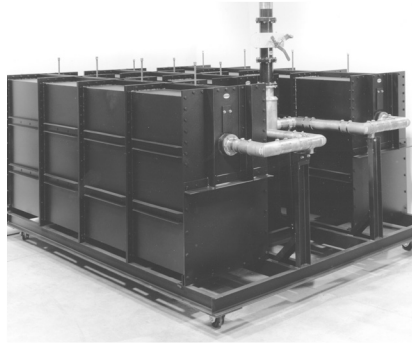

Specifications

Model Number	DFC14003BR3	DFC14004BR3	DFC14005BR3
Frequency	87.5...108 MHz	87.5...108 MHz	87.5...108 MHz
Combiner Type	Branch Combiner	Branch Combiner	Branch Combiner
Channel Spacing	>=2.8 MHz	>=1.2 MHz	>=0.8 MHz

Input 1, 2, 3

Average Power Handling	20 kW (per Input)	15 kW (per Input)	12 kW (per Input)
Average Power w/ Blowers	25 kW (per Input)	20 kW (per Input)	17 kW (per Input)
Temperature-compensated	YES	YES	YES

Insertion Loss

F0'	<=0.25 dB	<=0.35 dB	<=0.45 dB
VSWR	<=1.06	<=1.06	<=1.06
Group Delay Variation	<=50nS @ +/-150 KHz	<=70nS @ +/-150 KHz	<=160nS @ +/-150 KHz
Number of Cavities	3	4	5
Cavity Size	14"	14"	14"
Input Connector	EIA 3 1/8"	EIA 3 1/8"	EIA 3 1/8"
Output Connector	4 1/16" FLG	4 1/16" FLG	4 1/16" FLG
Isolation Between Inputs	>=35 dB	>=35 dB	>=35 dB
Material	AL+Cu Resonators +INVAR Roads	AL+Cu Resonators +INVAR Roads	AL+Cu Resonators +INVAR Roads
Ambient Temperature	32°F (0°C) to 104°F (+40°C)	32°F (0°C) to 104°F (+40°C)	32°F (0°C) to 104°F (+40°C)
Storage Temperature	32°F (0°C) to 122°F (+50°C)	32°F (0°C) to 122°F (+50°C)	32°F (0°C) to 122°F (+50°C)
Dimensions (LxWxH)	60" x 66" x 57" (1,524 mm x 1,677 mm x 1,448 mm)	73" x 66" x 57" (1,854 mm x 1,677 mm x 1,448 mm)	107" x 66" x 57" (2,718 mm x 1,677 mm x 1,448 mm)
Weight ³	1,465 lbs (665 kg)	1,925 lbs (873 kg)	2,385 lbs (1,082 kg)
Altitude ⁴	5,000 ft (1,524 m)	5,000 ft (1,524 m)	5,000 ft (1,524 m)
Application	FM/FM-HD	FM/FM-HD	FM/FM-HD

Notes:

1. F0 - Center Frequency
2. Estimated
3. For more than 5,000 ft (1,524 m), please consult the factory

3-10 CHANNEL

- For indoor applications
- Temperature-compensated
- High isolation
- FM and FM-HD channel bandwidths compliance
- Modular design

Dielectric's FM Branch Combiners are used when it is necessary to combine two (or three) FM channels into a single master antenna. Dielectric's combining systems are designed in modular fashion. The diplexing module is the fundamental building block. By cascading additional modules, new stations may be added.

All Dielectric filters have been designed with HD radio in mind. The passband parameters are optimized over the complete FM channel (+/- 200 kHz).

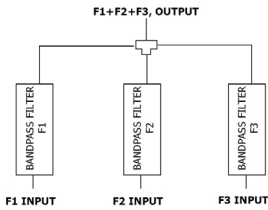

Notes:

1. F0 - Center Frequency
2. Estimated
3. For more than 5,000 ft (1,524 m), please consult the factory

Specifications

Model Number	DFC24003BR3	DFC24004BR3	DFC24005BR3
Frequency	87.5...108 MHz	87.5...108 MHz	87.5...108 MHz
Combiner Type	Branch Combiner	Branch Combiner	Branch Combiner
Channel Spacing	>=2.8 MHz	>=1.2 MHz	>=0.8 MHz
Input 1, 2			
Average Power Handling	28 kW (per Input)	23 kW (per Input)	20 kW (per Input)
Average Power w/ Blowers	38 kW (per Input)	33 kW (per Input)	30 kW (per Input)
Temperature-compensated	YES	YES	YES
Insertion Loss			
F0'	<=0.15 dB	<=0.25 dB	<=0.35 dB
VSWR	<=1.06	<=1.06	<=1.06
Group Delay Variation	<=50nS @ +/-150 KHz	<=70nS @ +/-150 KHz	<=160nS @ +/-150 KHz
Number of Cavities	3	4	5
Cavity Size	24"	24"	24"
Input Connector	EIA 3 1/8"	EIA 3 1/8"	EIA 3 1/8"
Output Connector	EIA 6 1/8"	EIA 6 1/8"	EIA 6 1/8"
Isolation Between Inputs	>=35 dB	>=35 dB	>=35 dB
Material	AL+Cu Resonators +INVAR Roads	AL+Cu Resonators +INVAR Roads	AL+Cu Resonators +INVAR Roads
Blowers & Shrouds	P>=25 kW (per Input)	P>=25 kW (per Input)	P>=25 kW (per Input)
Ambient Temperature	32°F (0°C) to 104°F (+40°C)	32°F (0°C) to 104°F (+40°C)	32°F (0°C) to 104°F (+40°C)
Storage Temperature	32°F (0°C) to 122°F (+50°C)	32°F (0°C) to 122°F (+50°C)	32°F (0°C) to 122°F (+50°C)
Dimensions (LxWxH)	90" x 95" x 57" (2,286 mm x 2,413 mm x 1,448 mm)	113" x 95" x 57" (2,870 mm x 2,413 mm x 1,448 mm)	137" x 95" x 57" (3,480 mm x 2,413 mm x 1,448 mm)
Weight ³	1,660 lbs (753 kg)	2,200 lbs (998 kg)	2,730 lbs (1,238 kg)
Altitude ⁴	5,000 ft (1,524 m)	5,000 ft (1,524 m)	5,000 ft (1,524 m)
Application	FM/FM-HD	FM/FM-HD	FM/FM-HD

3 CHANNEL TO 10 CHANNEL

- Combines 3 or more stations
- For indoor applications
- Temperature-compensated
- High isolation
- FM and FM-HD channel bandwidths compliance
- Modular design

Manifold combiners are an excellent alternative to constant impedance combiners. With proven performance up to 10 channels, a manifold will combine channels with less loss and with less space than a constant impedance combiner. One manifold spine will generally handle the peak voltages created when combining multiple IBOC channels better than the hybrids required for a CIF combiner. When channel assignments are known ahead of time, a manifold is the logical approach.

Specifications

Model Number	DFCXX00XMX
Total Average Power	140 kW
Frequency	87.5... 108 MHz
Combiner Type	MANIFOLD
Channel Spacing	≥ 1.2 MHz ¹
Insertion Loss	
F0 ²	≤ 0.35 dB ⁴
VSWR	≤ 1.08
Group Delay Variation	Channel Spacing Dependent
Number of Cavities	4 (or 3) ³
Cavity Size	14" (or 24")
Isolation Between Inputs	≥ 35 dB
Out Connector	4 1/16" FLG / 6 1/8" FLG
Average Power per Input	Channel Spacing Dependent
Material	AL + Cu Resonators + INVAR Roads
Ambient Temperature	32°F (0°C) to 104°F (+40°C)
Storage Temperature	32°F (0°C) to 122 (+50°C)
Dimensions (LxWxH)	Contact Factory
Weight (lbs)	Contact Factory
Altitude ¹	5,000 ft (1,524 m)
Application	FM/FM-HD

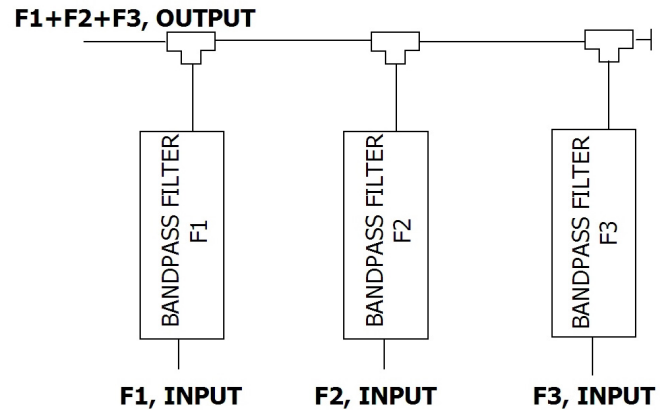

Notes:

1. For less than 1.2 MHz, please contact the factory
2. F0 - Center Frequency
3. Depends of the channel spacing
4. For more than 5,000 ft (1,524 m), please consult the factory
5. Optional blowers may be required for higher power
6. Varying with the cavity size and number of cavities per channel

MEDIUM POWER

- For indoor applications
- Temperature-compensated
- High isolation
- FM and FM-HD channel bandwidths compliance
- Modular design

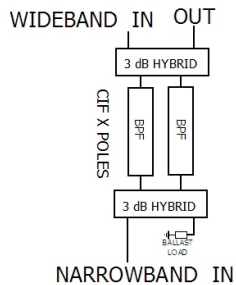
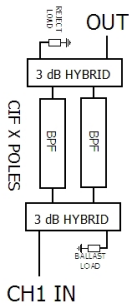

Notes:

1. For more than 5,000 ft (1,524 m), please consult the factory
2. F0 - Center Frequency
3. Estimated
4. Wideband group delay is added to narrow band delay of upstream filter

Specifications

Model Number	DFC14003CIF	DFC14004CIF	DFC14005CIF
Frequency	87.5...108 MHz	87.5...108 MHz	87.5...108 MHz
Combiner Type	Constant Impedance Filter	Constant Impedance Filter	Constant Impedance Filter
Channel Spacing	>=2.0 MHz	>=1.2 MHz	>=0.8 MHz

Narrow Band Input

Average Power Handling	40 kW	30 kW	24 kW
Average Power w/ Blowers	50 kW (per Input)	40 kW (per Input)	34 kW (per Input)
Temperature-compensated	YES	YES	YES

Insertion Loss

F0 ¹	<=0.25 dB	<=0.35 dB	<=0.45 dB
VSWR	<=1.06	<=1.06	<=1.06
Group Delay Variation	<=50nS @ +/-150 KHz	<=70nS @ +/-150 KHz	<=160nS @ +/-150 KHz
Number of Cavities	3	4	5
Cavity Size	14"	14"	14"
Input Hybrid	EIA 3 1/8"	EIA 3 1/8"	EIA 3 1/8"
Input Connector	EIA 1 5/8" or EIA 3 1/8"	EIA 1 5/8" or EIA 3 1/8"	EIA 1 5/8" or EIA 3 1/8"

Wide Band Input

Insertion Loss	<=0.1 dB	<=0.15 dB	<=0.2 dB
Group Delay Variation ²	<=20nS @ +/-150 KHz	<=30nS @ +/-150 KHz	<=200nS @ +/-150 KHz
VSWR	<=1.07	<=1.07	<=1.07
Input Connector	EIA 3 1/8" or 4 1/16" FLG	EIA 3 1/8" or 4 1/16" FLG	EIA 3 1/8" or 4 1/16" FLG

Isolation

NB to WB	>=35 dB	>=35 dB	>=35 dB
WB to NB	>=50 dB	>=55 dB	>=55 dB
Maximum Output Power Handling	70 kW	70 kW	70 kW
Output Hybrid	4 1/16" FLG	4 1/16" FLG	4 1/16" FLG
Output Connector	EIA 3 1/8" or 4 1/16" FLG	EIA 3 1/8" or 4 1/16" FLG	EIA 3 1/8" or 4 1/16" FLG
Material	AL+Cu Resonators +INVAR Roads	AL+Cu Resonators +INVAR Roads	AL+Cu Resonators +INVAR Roads
Ambient Temperature	32°F (0°C) to 104°F (+40°C)	32°F (0°C) to 104°F (+40°C)	32°F (0°C) to 104°F (+40°C)
Storage Temperature	32°F (0°C) to 122°F (+50°C)	32°F (0°C) to 122°F (+50°C)	32°F (0°C) to 122°F (+50°C)
Dimensions (LxWxH)	65" x 43" x 63" (1,651 mm x 1,092 mm x 1,600 mm)	84" x 43" x 63" (2,124 mm x 1,092 mm x 1,600 mm)	104" x 43" x 63" (2,642 mm x 1,092 mm x 1,600 mm)
Weight ³	1,120 lbs	1,445 lbs	1,766 lbs
Altitude ⁴	5,000 ft (1,524 m)	5,000 ft (1,524 m)	5,000 ft (1,524 m)
Application	FM/FM-HD	FM/FM-HD	FM/FM-HD

VERY HIGH-POWER

- For indoor applications
- Temperature-compensated
- High isolation
- FM and FM-HD channel bandwidths compliance
- Modular design

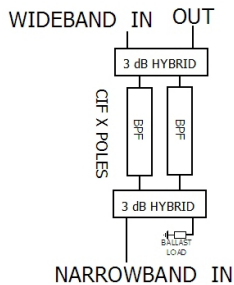
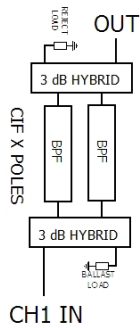

Notes:

1. F0 - Center Frequency
2. Wideband group delay is added to narrow band delay of upstream modules
3. Estimated
4. For more than 5,000 ft (1,524 m), please consult the factory

Specifications

Model Number	DFC24003CIF	DFC24004CIF	DFC24005CIF
Frequency	87.5...108 MHz	87.5...108 MHz	87.5...108 MHz
Combiner Type	Constant Impedance Filter	Constant Impedance Filter	Constant Impedance Filter
Channel Spacing	>=2.0 MHz	>=1.2 MHz	>=0.8 MHz

Narrow Band Input

Average Power Handling	56 kW	46 kW	40 kW
Average Power w/ Blowers	70 kW (per Input)	66 kW (per Input)	60 kW (per Input)
Temperature-compensated	YES	YES	YES

Insertion Loss

F0 ¹	<=0.15 dB	<=0.25 dB	<=0.35 dB
VSWR	<=1.06	<=1.06	<=1.06
Group Delay Variation	<=50nS @ +/-150 KHz	<=70nS @ +/-150 KHz	<=160nS @ +/-150 KHz
Number of Cavities	3	4	5
Cavity Size	24"	24"	24"
Input Hybrid	4 1/16" FLG	4 1/16" FLG	4 1/16" FLG
Input Connector	EIA 3 1/8" or 4 1/16" FLG	EIA 3 1/8" or 4 1/16" FLG	EIA 3 1/8" or 4 1/16" FLG

Wide Band Input

Insertion Loss	<=0.1 dB	<=0.15 dB	<=0.2 dB
Group Delay Variation ²	<=20nS @ +/-150 KHz	<=30nS @ +/-150 KHz	<=200nS @ +/-150 KHz
VSWR	<=1.07	<=1.07	<=1.07
Input Connector	4 1/16" FLG or EIA 6 1/8"	4 1/16" FLG or EIA 6 1/8"	4 1/16" FLG or EIA 6 1/8"

Isolation

NB to WB	>=35 dB	>=35 dB	>=35 dB
WB to NB	>=50 dB	>=55 dB	>=55 dB
Maximum Output Power Handling	120 kW	120 kW	120 kW
Output Hybrid	EIA 6 1/8"	EIA 6 1/8"	EIA 6 1/8"
Output Connector	4 1/16" FLG or EIA 6 1/8"	4 1/16" FLG or EIA 6 1/8"	4 1/16" FLG or EIA 6 1/8"
Material	AL+Cu Resonators +INVAR Roads	AL+Cu Resonators +INVAR Roads	AL+Cu Resonators +INVAR Roads
Ambient Temperature	32°F (0°C) to 104°F (+40°C)	32°F (0°C) to 104°F (+40°C)	32°F (0°C) to 104°F (+40°C)
Storage Temperature	32°F (0°C) to 122°F (+50°C)	32°F (0°C) to 122°F (+50°C)	32°F (0°C) to 122°F (+50°C)
Dimensions (LxWxH)	107" x 58" x 66" (2.667 mm x 1.473 mm x 1.676 mm)	133" x 58" x 66" (3.378 mm x 1.473 mm x 1.676 mm)	158" x 58" x 66" (4.013 mm x 1.473 mm x 1.676 mm)
Weight ³	1265 lbs	1630 lbs	1990 lbs
Altitude ⁴	5,000 ft (1,524 m)	5,000 ft (1,524 m)	5,000 ft (1,524 m)
Application	FM/FM-HD	FM/FM-HD	FM/FM-HD

VERY HIGH-POWER

- For indoor applications
- Temperature-compensated
- High isolation
- FM and FM-HD channel bandwidths compliance
- Modular design

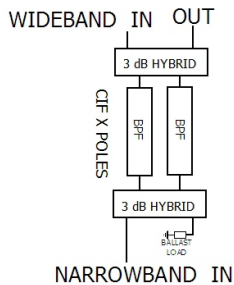
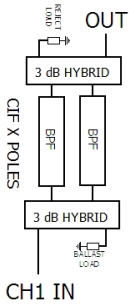

Notes:

1. F0 - Center Frequency
2. Wideband group delay is added to narrow band delay of upstream modules
3. Estimated
4. For more than 5,000 ft (1,524 m), please consult the factory

Specifications

Model Number	DFC24003CIF-H	DFC24004CIF-H	DFC24005CIF-H
Frequency	87.5...108 MHz	87.5...108 MHz	87.5...108 MHz
Combiner Type	Constant Impedance Filter	Constant Impedance Filter	Constant Impedance Filter
Channel Spacing	>=2.0 MHz	>=1.2 MHz	>=0.8 MHz

Narrow Band Input

Average Power Handling	56 kW	46 kW	40 kW
Average Power w/ Blowers	P>=70 kW (per Input)	P>=66 kW (per Input)	P>=60 kW (per Input)
Temperature-compensated	YES	YES	YES

Insertion Loss

F0 ¹	<=0.15 dB	<=0.25 dB	<=0.35 dB
VSWR	<=1.06	<=1.06	<=1.06
Group Delay Variation	<=50nS @ +/-150 KHz	<=70nS @ +/-150 KHz	<=160nS @ +/-150 KHz
Number of Cavities	3	4	5
Cavity Size	24"	24"	24"
Input Hybrid	EIA 6 1/8"	EIA 6 1/8"	EIA 6 1/8"
Input Connector	4 1/16" FLG or EIA 6 1/8"	4 1/16" FLG or EIA 6 1/8"	4 1/16" FLG or EIA 6 1/8"

Wide Band Input

Insertion Loss	<=0.1 dB	<=0.15 dB	<=0.2 dB
Group Delay Variation ²	<=20nS @ +/-150 KHz	<=30nS @ +/-150 KHz	<=200nS @ +/-150 KHz
VSWR	<=1.07	<=1.07	<=1.07
Input Connector	EIA 6 1/8" or EIA 9 3/16"	EIA 6 1/8" or EIA 9 3/16"	EIA 6 1/8" or EIA 9 3/16"

Isolation

NB to WB	>=35 dB	>=35 dB	>=35 dB
WB to NB	>=50 dB	>=55 dB	>=55 dB
Maximum Output Power Handling	250 kW	250 kW	250 kW
Output Hybrid	EIA 9 3/16"	EIA 9 3/16"	EIA 9 3/16"
Output Connector	EIA 6 1/8" or EIA 9 3/16"	EIA 6 1/8" or EIA 9 3/16"	EIA 6 1/8" or EIA 9 3/16"
Material	AL+Cu Resonators +INVAR Roads	AL+Cu Resonators +INVAR Roads	AL+Cu Resonators +INVAR Roads
Ambient Temperature	32°F (0°C) to 104°F (+40°C)	32°F (0°C) to 104°F (+40°C)	32°F (0°C) to 104°F (+40°C)
Storage Temperature	32°F (0°C) to 122°F (+50°C)	32°F (0°C) to 122°F (+50°C)	32°F (0°C) to 122°F (+50°C)
Dimensions (LxWxH)	112" x 58" x 70" (2.845 mm x 1.473 mm x 1.778 mm)	138" x 58" x 70" (3.505 mm x 1.473 mm x 1.778 mm)	163" x 58" x 70" (4.140 mm x 1.473 mm x 1.778 mm)
Weight ³	1295 lbs	1660 lbs	2020 lbs
Altitude ⁴	5,000 ft (1,524 m)	5,000 ft (1,524 m)	5,000 ft (1,524 m)
Application	FM/FM-HD	FM/FM-HD	FM/FM-HD



Dielectric products are represented in 90 countries around the world. With the rapid expansion of communications, Dielectric is positioned to service the broadcast needs of small & large stations, DTV, FM & specialty RF systems, complete systems and components.

Dielectric®

Specifications subject to change without notice.

NORTH AMERICA

- > BELIZE
- > CANADA
- > COSTA RICA
- > DOMINICAN REPUBLIC
- > EL SALVADOR
- > GREENLAND
- > GUATEMALA
- > MEXICO
- > NICARAGUA
- > PUERTO RICO
- > UNITED STATES

SOUTH AMERICA

- > ARGENTINA
- > BRAZIL
- > CHILE
- > COLOMBIA
- > ECUADOR
- > PERU
- > VENEZUELA

EUROPE

- > AUSTRIA
- > BELGIUM
- > DENMARK
- > ENGLAND
- > FINLAND
- > FRANCE
- > GERMANY
- > GREECE
- > ICELAND
- > IRELAND
- > ITALY
- > MALTA
- > NETHERLANDS
- > NORWAY
- > POLAND
- > PORTUGAL
- > ROMANIA
- > RUSSIA
- > SPAIN
- > SWEDEN
- > SWITZERLAND

ASIA

- > ABU DHABI
- > CHINA
- > GUAM
- > HONG KONG
- > INDIA
- > INDONESIA
- > ISRAEL
- > JAPAN
- > JORDAN
- > KOREA
- > KUWAIT
- > LEBANON
- > MALAYSIA
- > MONGOLIA
- > NEPAL
- > OMAN
- > PAKISTAN
- > PHILIPPINES
- > QATAR
- > SAIPAN
- > SAUDI ARABIA
- > SINGAPORE
- > SRI LANKA
- > SYRIA
- > TAIWAN
- > THAILAND
- > VIETNAM
- > YEMEN

AFRICA

- > ANGOLA
- > BENIN
- > BOTSWANA
- > CHAD
- > EGYPT
- > ETHIOPIA
- > GHANA
- > LIBERIA
- > MADAGASCAR
- > MALI
- > MAURITANIA
- > MAURITIUS
- > MOROCCO
- > NIGERIA
- > SAO TOME
- > SOUTH AFRICA
- > TOGO
- > UGANDA
- > ZAMBIA
- > ZIMBABWE

OCEANIA

- > AUSTRALIA
- > NEW ZEALAND
- > PAPUA NEW GUINEA