

Dielectric®

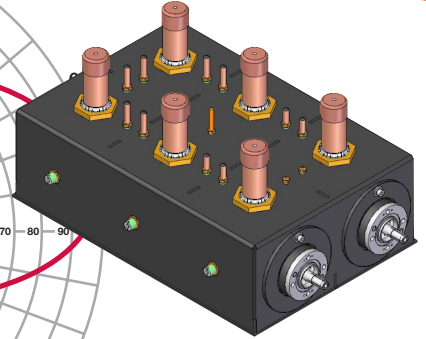

POWERLITE™ Series

Antennas | Antenna Systems | Filters

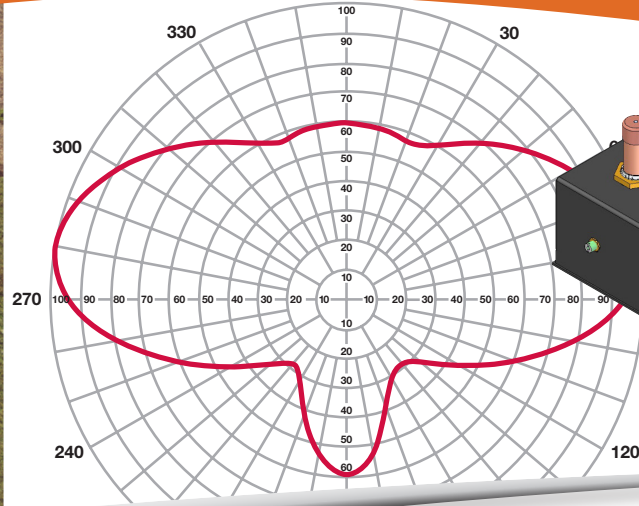

Engineering Excellence since 1942



Table of Contents

About Dielectric.....2

Antennas

POWERLITE™ TLP UHF Antenna.....3
POWERLITE™ TLP-BB Low Power Antenna7
POWERLITE™ DLP Low Power Antenna9
POWERLITE™ TUL UHF CP Antenna..... 11
POWERLITE™ TUM-LP UHF CP Antenna14
POWERLITE™ TUA-M Broadband UHF Antenna17
POWERLITE™ TFU-UT Bowtie Slot Turnstile Antenna20
POWERLITE™ DCR-T FM Antenna22
POWERLITE™ DCR-L FM Antenna24

ATSC Full Mask and Stringent Mask Compliance

Tunable UHF Bandpass Filters

POWERLITE™ 100 W26
POWERLITE™ 130 W27
POWERLITE™ 150 W29
POWERLITE™ 250 W 30
POWERLITE™ 600 W33
POWERLITE™ 1.5 kW..... 36
POWERLITE™ 3.0 kW..... 39
POWERLITE™ 6.0 kW.....42
POWERLITE™ 7.0 kW43
Filter Masks45

Specifications are subject to change without notice.

Leading the broadcast industry since 1942

Dielectric is a world leader in the innovative engineering, design, and manufacturing of complete broadcast systems for TV and FM. The broadcast systems can include the antennas, elbow complexes, transmission lines, RF switches, RF filters, channel combiners and pressurizing equipment. Dielectric's strength is in the development of custom solutions that fit the customer's unique requirements.

Introducing **POWERLITE™** Low Power Antenna Systems

Dielectric's latest product line is the new **POWERLITE™** line of low power antenna systems. Dielectric's engineers used high power design techniques to design this new low power product line, to produce a very durable and trouble-free system. The **POWERLITE™** line is the most cost-efficient product offering for customers with broadcast power requirements of 6 kW or less. **POWERLITE™** low power antenna systems offer all of the required components for a stand-alone broadcast system and they're backed by Dielectric's 70 years of expertise in the broadcast industry.

Unique RF products for better broadcast quality

Dielectric offers many antenna solutions within **POWERLITE™**. The innovative line of antennas offer many standard azimuth and elevation patterns that can be mounted on many different structures, and can handle a single channel or broadband to handle many channels simultaneously. If there is a special requirement a custom solution can be engineered.

Dielectric's **POWERLITE™** RF mask filters are designed to specific power, specific mask and channel tunable to provide excellent performance and versatility at economical price.

If there is a special requirement a custom solution can be engineered.

Guaranteed quality and reliability

Dielectric's confidence in their design and durability leads to one of the best warranties in the industry; covering all the components supplied, from transmitter output through the switches, filters, combiners, transmission line and antenna.

Dielectric's POWERLITE™ — the name you can trust in low power antenna systems.



Dielectric's TLP Series antenna is designed for single channel, low wind load, horizontal, circular or elliptically polarized operation.

Dielectric Advantages

- Operating Range: 6 MHz band within 470-860 MHz
- Pattern optimization available – factory test using location and orientation on supporting tower to minimize tower effects. Might require custom mounts.
- Suitable for analog or DTV applications
- DTV ERPs up to 1300 kW
- 17 different standard azimuth patterns available
- 4 standard elevation gains available
- Available horizontally, elliptically or circularly polarized
- Low VSWR, < 1.1:1 over operating channel
- Slot covers provide ice protection
- Standard mounting brackets included
- 1-5/8" EIA input standard, 3-1/8" EIA available
- Custom azimuth and elevation patterns available

Specifications

Maximum Input Power Rating DTV (Average) / NTSC (peak)*

Antenna	Standard		Custom		Special	
	Ch. 14	Ch. 69	Ch. 14	Ch. 69	Ch. 14	Ch. 69
TLP-8	5.0/8.6	5.0/6.4	—	—	—	—
TLP-16	4.0/6.1	3.0/4.5	8.0/13.0	7.0/9.7	8.0/24.0	8.0/24.0
TLP-24	4.9/7.0	3.7/5.3	8.8/15.0	7.9/11.3	11.6/35.0	11.6/24.0
TLP-32	7.0/10.0	5.2/7.5	12.5/21.4	11.2/16.1	11.6/35.0	11.6/24.0

Input: 1-5/8" EIA on Standard, 3-1/8" EIA on Custom and Special

*NTSC: Peak Sync + 10% aural

Mounting Options

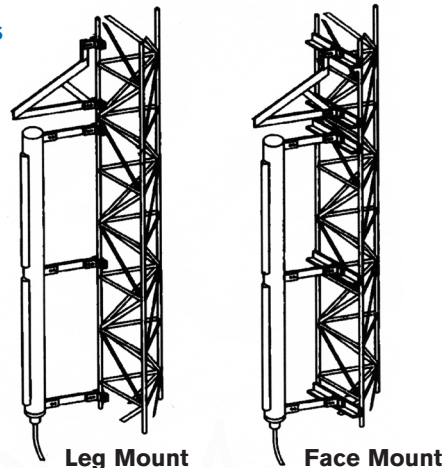

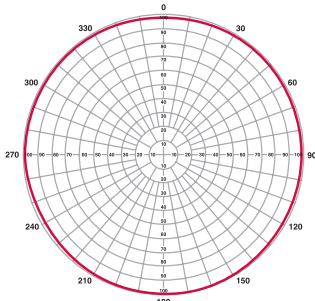

TLP-A
Azimuth Gain=1.0

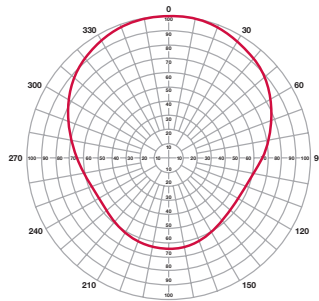

TLP-B
Azimuth Gain=1.7

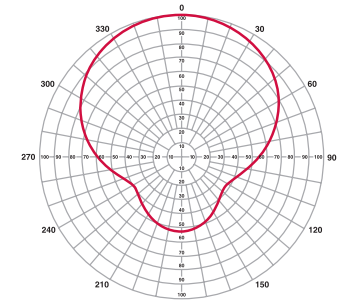

TLP-C
Azimuth Gain=2.1

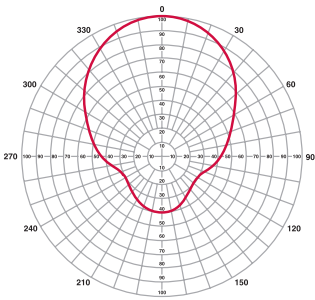

TLP-D
Azimuth Gain=2.9

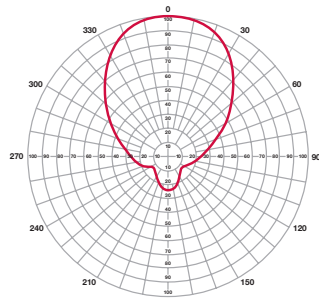

TLP-E
Azimuth Gain=3.9

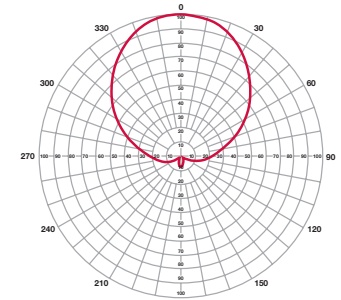

TLP-F
Azimuth Gain=3.6

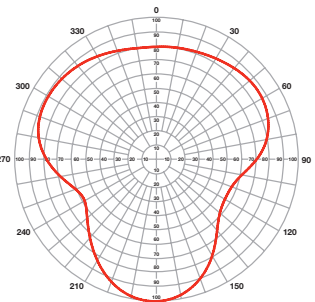

TLP-G
Azimuth Gain=1.6

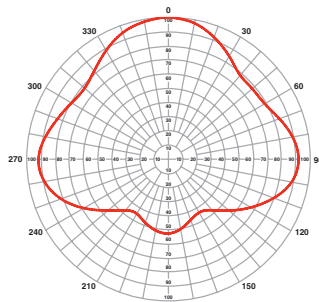

TLP-H
Azimuth Gain=1.7

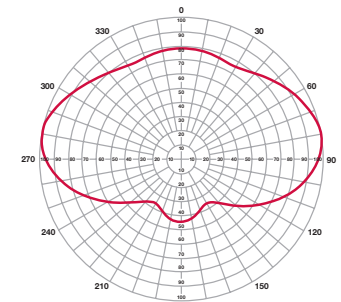

TLP-I
Azimuth Gain=1.8

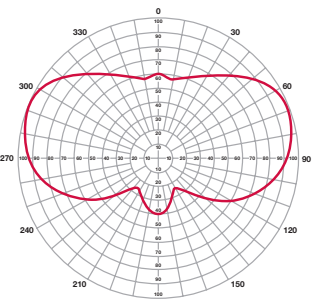

TLP-J
Azimuth Gain=2.0

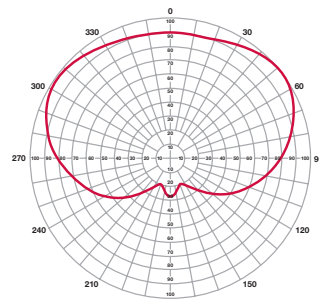

TLP-M
Azimuth Gain=1.9

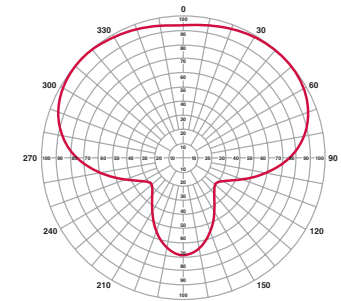

TLP-N
Azimuth Gain=1.7

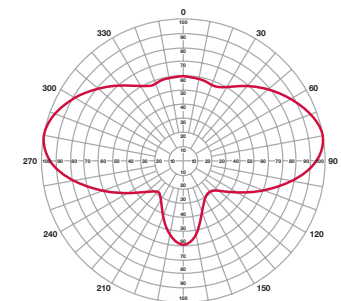

TLP-O
Azimuth Gain=2.2

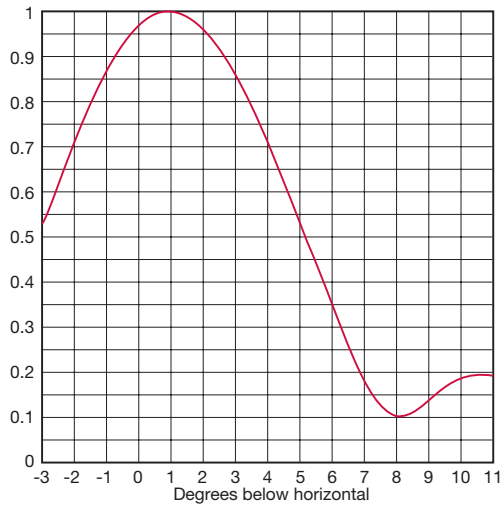

TLP-8

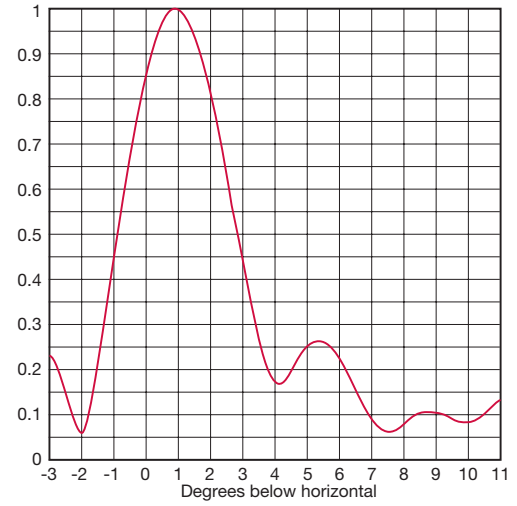

TLP-16

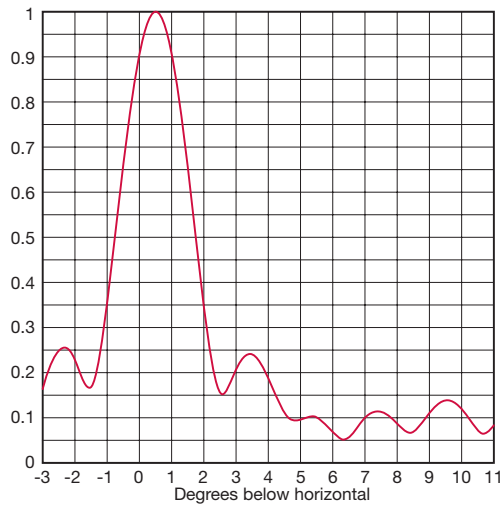

TLP-24

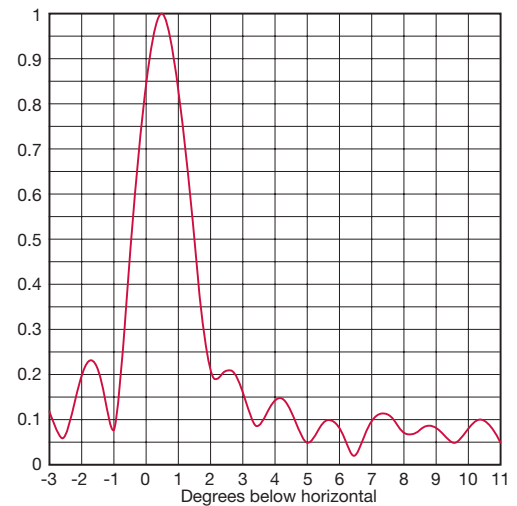

TLP-32

Custom beam tilts available to meet your specific requirements.
 Please contact Dielectric for more information.

Antenna Specifications, TLP UHF Antenna

The tables reflect minimum values for 860 MHz and maximum for 470 MHz. For other frequencies the height (H), weight (W) and windload (WL) can be interpolated using formula: $H, W, \text{ or } WL \text{ at } f = \text{MAX} - (f-860) * (\text{MIN}-\text{MAX})/390$

Center of radiation is one half of the Height: $C/R = 0.5 * H$

- For circular polarization divide Peak gain by 2 (subtract 3dB)
- For elliptical polarization contact factory
- Peak gain is relative to half wave dipole

Antenna Type	Azimuth Pattern	Peak Power Gain Ratio	Gain (dBd)	Height (ft)	Weight (lb)	Windload ¹ (lb)
TLP-8A	TLP-A	8.0	9.0		65 to 105	190 to 320
TLP-8B	TLP-B	13.6	11.3		45 to 70	180 to 300
TLP-8C	TLP-C	16.8	12.3		50 to 85	310 to 760
TLP-8D	TLP-D	23.2	13.7		50 to 85	300 to 710
TLP-8E	TLP-E	31.2	14.9		65 to 135	370 to 910
TLP-8F	TLP-F	28.8	14.6	10.5	60 to 110	260 to 530
TLP-8G	TLP-G	12.8	11.1	to	55 to 100	180 to 310
TLP-8H	TLP-H	13.6	11.3	17.8	50 to 85	260 to 530
TLP-8I	TLP-I	14.4	11.6		50 to 85	260 to 530
TLP-8J	TLP-J	16.0	12.0		50 to 95	380 to 980
TLP-8M	TLP-M	15.2	11.8		50 to 85	260 to 610
TLP-8N	TLP-N	13.6	11.3		50 to 85	210 to 580
TLP-8O	TLP-O	17.6	12.4		55 to 100	370 to 630
TLP-16A	TLP-A	16.0	12.0		150 to 230	435 to 700
TLP-16B	TLP-B	27.2	14.3		110 to 160	410 to 650
TLP-16C	TLP-C	33.6	15.3		120 to 190	680 to 1580
TLP-16D	TLP-D	46.4	16.7		120 to 190	660 to 1480
TLP-16E	TLP-E	62.4	18.0		150 to 290	800 to 1880
TLP-16F	TLP-F	57.6	17.6	22.2	140 to 240	580 to 1120
TLP-16G	TLP-G	25.6	14.1	to	130 to 220	420 to 680
TLP-16H	TLP-H	27.2	14.3	37.5	120 to 190	580 to 1120
TLP-16I	TLP-I	28.8	14.6		120 to 190	580 to 1120
TLP-16J	TLP-J	32.0	15.1		120 to 210	820 to 2020
TLP-16M	TLP-M	30.4	14.8		120 to 190	580 to 1280
TLP-16N	TLP-N	27.2	14.3		120 to 190	480 to 1220
TLP-16O	TLP-O	35.2	15.5		130 to 220	800 to 1320
TLP-24A	TLP-A	23.0	13.6		225 to 345	675 to 1070
TLP-24B	TLP-B	39.1	15.9		170 to 245	635 to 1000
TLP-24C	TLP-C	48.3	16.8		185 to 290	1040 to 2390
TLP-24D	TLP-D	66.7	18.2		185 to 290	1010 to 2240
TLP-24E	TLP-E	89.7	19.5		230 to 440	1220 to 2840
TLP-24F	TLP-F	82.8	19.2	33.8	215 to 365	890 to 1700
TLP-24G	TLP-G	36.8	15.7	to	200 to 335	650 to 1040
TLP-24H	TLP-H	39.1	15.9	57.3	185 to 290	890 to 1700
TLP-24I	TLP-I	41.4	16.2		185 to 290	890 to 1700
TLP-24J	TLP-J	46.0	16.6		185 to 320	1250 to 3050
TLP-24M	TLP-M	43.7	16.4		185 to 290	890 to 1940
TLP-24N	TLP-N	39.1	15.9		185 to 290	740 to 1850
TLP-24O	TLP-O	50.6	17.0		200 to 235	1220 to 2000
TLP-32A	TLP-A	31.0	14.9		300 to 460	930 to 1450
TLP-32B	TLP-B	52.7	17.2		220 to 480	760 to 1200
TLP-32C	TLP-C	65.1	18.1		240 to 380	1360 to 3160
TLP-32D	TLP-D	89.9	19.5		240 to 380	1320 to 2960
TLP-32E	TLP-E	120.9	20.8		300 to 580	1600 to 3760
TLP-32F	TLP-F	111.6	20.5	45.5	280 to 480	1160 to 2240
TLP-32G	TLP-G	49.6	17.0	to	260 to 440	840 to 1360
TLP-32H	TLP-H	52.7	17.2	77.1	240 to 380	1160 to 2240
TLP-32I	TLP-I	55.8	17.5		240 to 380	1160 to 2240
TLP-32J	TLP-J	62.0	17.9		240 to 420	1640 to 4040
TLP-32M	TLP-M	58.9	17.7		240 to 380	1160 to 2560
TLP-32N	TLP-N	52.7	17.2		240 to 380	690 to 2440
TLP-32O	TLP-O	68.2	18.3		260 to 440	1600 to 2640

¹ Windload at 50/33 lb/ft² per EIA RS-222C



Dielectric's TLP-BB Series antenna is designed specifically for multichannel operation with low wind load.

Dielectric Advantages

- Operating Range: 60 MHz band within 470-860 MHz
- Economical broadband design
- Suitable for multiplexing many channels
- DTV ERPs up to 100 kW
- 2 standard azimuth patterns available
- Stable elevation pattern with gain of 12 with 2 degrees nominal beam tilt
- Available horizontally, elliptically or circularly polarized
- Low VSWR, < 1.15:1 over operating band
- Slot covers provide ice protection
- Standard mounting brackets included for 1-1/4" to 4-1/2" OD pipes
- 3-1/8" EIA input standard
- Survives winds up to 125 mph (56 m/s)

Antenna Specifications

Band	Polarization	VSWR	Input	Power Rating	Beam Tilt
UHF (470-860 MHz)	Horizontal or Elliptical	1.15:1 Up to 10 channels bandwidth	3-1/8" 50 Ω EIA	5 kW Max. average	2.0° nominal.

The tables reflect minimum values for 860 MHz and maximum for 470 MHz. For other frequencies the height (H), weight (W) and windload (WL) can be interpolated using formula: $H, W, \text{ or } WL \text{ at } f = \text{MAX} - (f-860) * (\text{MIN}-\text{MAX})/390$

Center of radiation is one half of the Height: $C/R = 0.5 * H$

- For elliptical polarization contact factory

Antenna Type	Azimuth Pattern	Peak Power Gain Ratio	Gain (dBd)	Height ft (m)	Weight lb (kg)	Wind Area ¹ ft ² (m ²)
TLP-12-BB-B	TLP-B	17.9	12.5	16.0 to 27.1 (4.9 to 8.3)	167 to 216 (76 to 98)	22.6 to 31.6 (2.1 to 2.9)
TLP-12-BB-M	TLP-M	20.0	13.0	16.0 to 27.1 (4.9 to 8.3)	202 to 310 (92 to 141)	34.0 to 69.3 (3.2 to 6.4)

¹ Wind area $C_A A_C$ per TIA/EIA-222-F ($C_A = 1.2$)

Azimuth and Elevation Patterns, TLP-BB Antenna

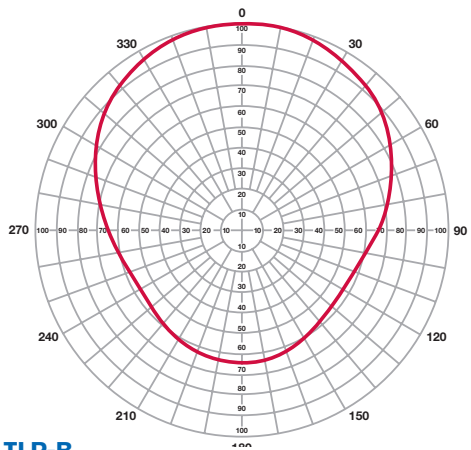

TLP-B
Azimuth gain=1.7

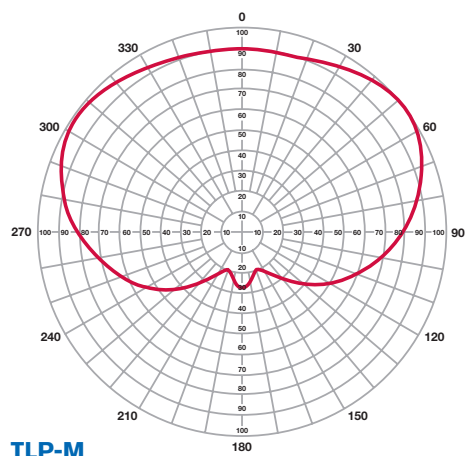

TLP-M
Azimuth gain=1.9

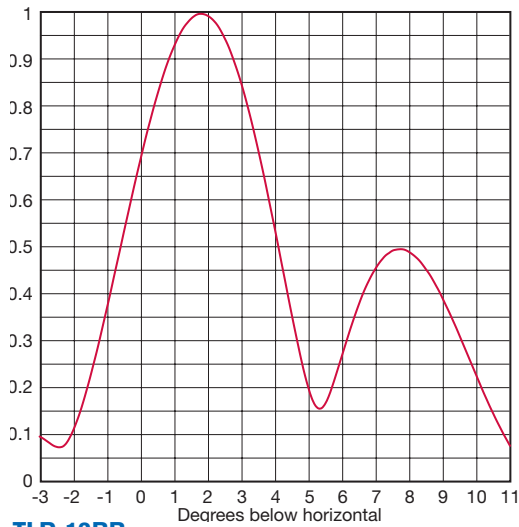

TLP-12BB

Custom patterns are available to meet your specific requirements.
Please contact Dielectric for more information.

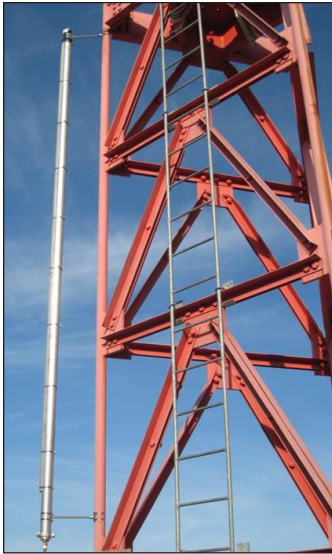

Dielectric's DLP Series antenna is designed specifically as an economical single channel choice for low power TV, DTV, and gap filling.

Dielectric Advantages

- Operating Range: 6 MHz band within 470-860 MHz
- Economical single section 8-bay design
- Suitable for analog or DTV applications on a channel
- DTV ERPs up to 35 kW
- 5 different standard azimuth patterns available
- Elevation pattern with gain of 8 with 1.5 degrees nominal beam tilt
- Available horizontally and elliptically polarized with 30% vertical
- Low VSWR, < 1.1:1 over operating channel
- Slot covers provide environmental protection
- Standard mounting brackets included for 1-1/4" to 4-1/2" OD pipes
- Low weight and windload
- 7/8" EIA input standard
- Survives winds up to 125 mph (56 m/s)

Antenna Specifications

Band	Polarization	VSWR	Input	Power Rating	Beam Tilt
UHF (470-860 MHz)	Horizontal or Elliptical	1.1:1	7/8" 50 Ω EIA	1.6 kW average	1.5° nominal.

The tables reflect minimum values for 860 MHz and maximum for 470 MHz. For other frequencies the height (H), weight (W) and windload (WL) can be interpolated using formula: $H, W, \text{ or } WL \text{ at } f = \text{MAX} - (f-860) * (\text{MIN}-\text{MAX})/390$

Center of radiation is one half of the Height: $C/R = 0.5 * H$

- For elliptical polarization contact factory

Antenna Type	Azimuth Pattern	Peak Power Gain Ratio	Gain (dBd)	Height ft (m)	Weight lb (kg)	Wind Area ¹ ft ² (m ²)
DLP-8-B	TLP-B	13.6	11.3	12.2 to 18.8 (3.7 to 5.7)	39.2 to 57.5 (17.8 to 26.1)	5.5 to 8.5 (0.8 to 1.3)
DLP-8-D	TLP-D	23.2	13.7	12.2 to 18.8 (3.7 to 5.7)	42.2 to 64.6 (19.2 to 29.4)	7.6 to 13.6 (1.2 to 2.1)
DLP-8-H	TLP-H	13.6	11.3	12.2 to 18.8 (3.7 to 5.7)	41.8 to 73.2 (19.0 to 33.3)	7.2 to 19.4 (1.1 to 3.0)
DLP-8-J	TLP-J	16.0	12.0	12.2 to 18.8 (3.7 to 5.7)	41.5 to 71.0 (18.9 to 32.3)	6.8 to 16.1 (1.0 to 2.5)
DLP-8-M	TLP-M	15.2	11.8	12.2 to 18.8 (3.7 to 5.7)	42.1 to 75.1 (19.2 to 34.1)	7.6 to 21.0 (1.2 to 3.2)

¹ Wind area $C_A A_C$ per TIA/EIA-222-F ($C_A = 1.2$)

Azimuth and Elevation Patterns, DLP Low Power Antenna

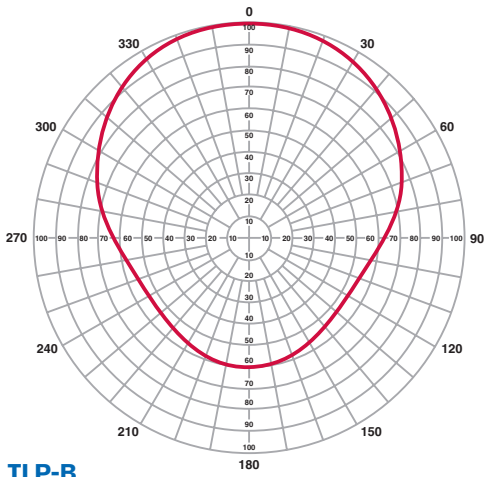

TLP-B
Azimuth gain=1.7

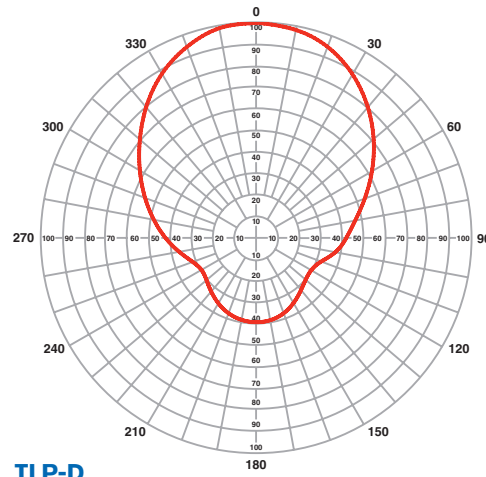

TLP-D
Azimuth gain=2.9

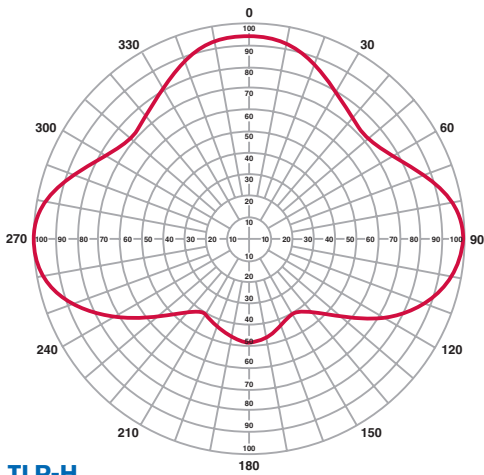

TLP-H
Azimuth gain=1.7

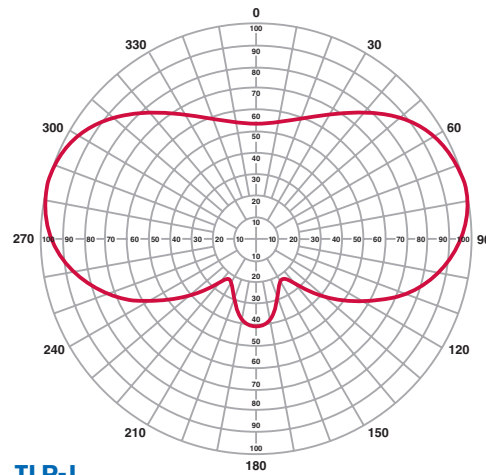

TLP-J
Azimuth gain=2.0

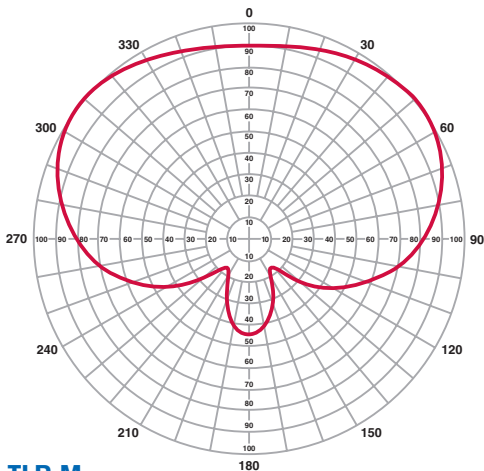

TLP-M
Azimuth gain=1.9

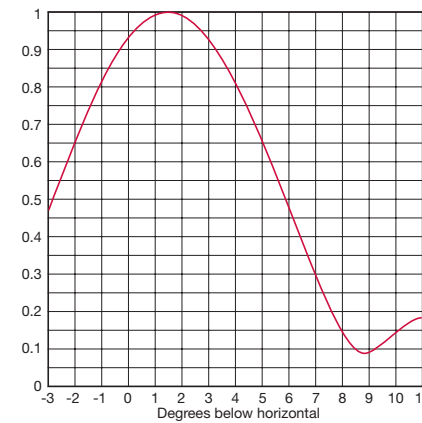

DLP-8

In addition to these standard patterns, we can customize a pattern to meet your specific needs. *Please contact us for more information.*



Dielectric's TUL Series panel antenna is designed for medium bandwidth using circular polarization.

Dielectric Advantages

- Operating Range: 60 MHz band within 470-860 MHz
- Circularly polarized panel
- Economical broadband design
- A key building block for antennas with different azimuth and elevation patterns
- Suitable for analog or DTV applications on many channels
- 500 W average power per panel with 7-16 DIN input
- 4 standard azimuth patterns available
- Low VSWR, < 1.1:1 over operating band
- Aluminum construction
- ABS radome for environmental protection
- Custom azimuth and elevation patterns available upon request

Electrical Specifications – Individual Panel

Band	Polarization	VSWR	Input	Power Rating
UHF ch. 14-23 ch. 24-32 ch. 33-41 ch. 42-52	Circular	1.1:1	7-16 DIN	500 W

Mechanical Specifications – Individual Panel

Model	Height ft (m)	Weight lb (kg)	Wind Area ¹ ft ² (m ²)	Dimensions LxWxD (in)
TUL UHF CP	3.2 (1.0)	20 (9.1)	6.8 (0.63)	38.25 x 18.25 x 8.10

¹ Wind area $C_A A_C$ per TIA/EIA-222-F ($C_A = 1.4$)

Azimuth Patterns, TUL UHF CP Antenna

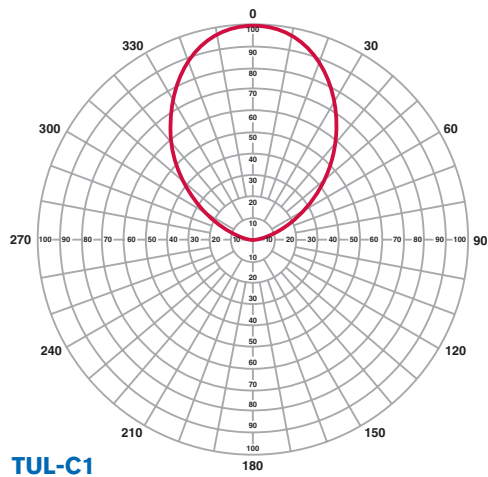

TUL-C1
Azimuth gain=5.2

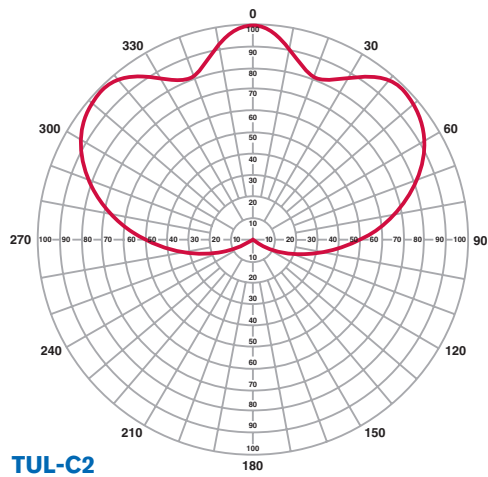

TUL-C2
Azimuth gain=2.6

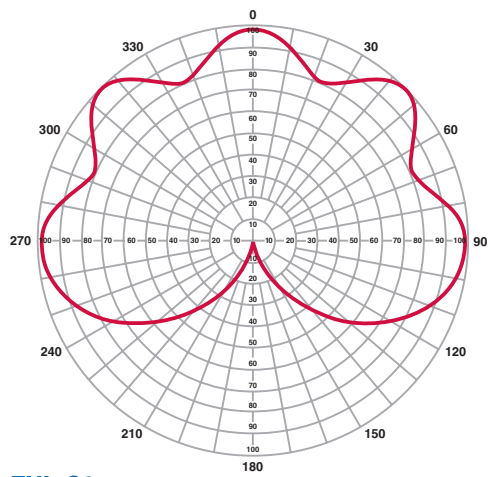

TUL-C3
Azimuth gain=1.8

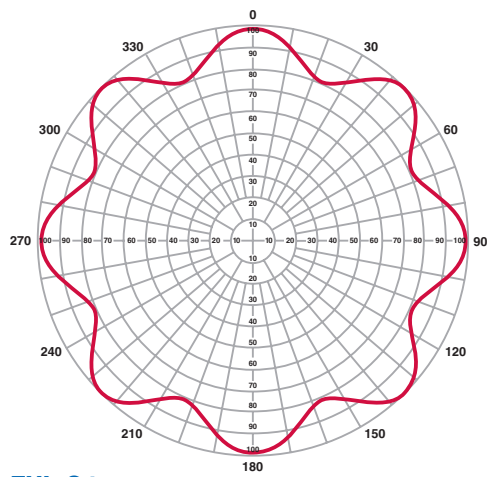

TUL-O4
Azimuth gain=1.3

Notes:

1. Patterns shown are typical and calculated using a 24" square tower at 587 MHz. Specific gains and patterns will be supplied with the proposal.

Antenna Type	Azimuth Pattern	Peak Gain (ratio)	Peak Gain (dBd)	Weight lb (kg)	Avg. Power (kW)	Antenna Height ft (m)	$C_A A_C$ (CA=1.4) ft ² (m ²)
TUL-C1-1/1	TUL-C1	5.2	7.2	20.0 (9.1)	.5	3.2 (1.0)	6.8 (0.63)
TUL-C1-2/2	TUL-C1	11.5	10.6	51.8 (23.5)	1	6.8 (2.1)	15.4 (1.43)
TUL-C1-3/3	TUL-C1	17.7	12.5	74.1 (33.7)	1.5	10.4 (3.2)	23.1 (2.15)
TUL-C1-4/4	TUL-C1	23.4	13.7	97.2 (44.2)	2	13.9 (4.3)	31.2 (2.90)
TUL-C2-1/2	TUL-C2	2.6	4.2	51.8 (23.5)	1	3.2 (1.0)	13.3 (1.23)
TUL-C2-2/4	TUL-C2	5.7	7.6	95.4 (43.4)	2	6.8 (2.1)	26.3 (2.45)
TUL-C2-3/6	TUL-C2	8.9	9.5	140.8 (64.0)	3	10.4 (3.2)	40.1 (3.73)
TUL-C2-4/8	TUL-C2	11.7	10.7	188.0 (85.5)	4	13.9 (4.3)	54.6 (5.08)
TUL-C3-1/3	TUL-C3	1.8	2.6	72.7 (33.0)	1.5	3.2 (1.0)	17.4 (1.61)
TUL-C3-2/6	TUL-C3	4.0	6.0	138.1 (62.8)	3	6.8 (2.1)	34.9 (3.24)
TUL-C3-3/9	TUL-C3	6.1	7.9	206.2 (93.7)	4.5	10.4 (3.2)	53.5 (4.98)
TUL-C3-4/12	TUL-C3	8.1	9.1	297.0 (135.0)	6	13.9 (4.3)	75.3 (7.00)
TUL-O4-1/4	TUL-O4	1.3	1.1	93.6 (42.5)	2	3.2 (1.0)	21.5 (1.99)
TUL-O4-2/8	TUL-O4	2.9	4.6	180.8 (82.2)	4	6.8 (2.1)	43.4 (4.04)
TUL-O4-3/12	TUL-O4	4.4	6.4	291.6 (132.5)	6	10.4 (3.2)	68.9 (6.41)
TUL-O4-4/16	TUL-O4	5.9	7.7	386.0 (175.5)	8	13.9 (4.3)	93.9 (8.73)

- Peak gain is per polarization
- Wind area $C_A A_C$ per TIA/EIA-222-F ($C_A = 1.4$)
- Weight excludes brackets and mounting hardware, includes typical feed system



Dielectric's TUM-LP Series panel antenna is designed for broadband circular or elliptical polarization.

Dielectric Advantages

- Operating Range: 470-806 MHz
- Circularly or elliptically polarized panel
- Economical broadband design
- A key building block for antennas with different azimuth and elevation patterns
- Suitable for multiplexing many channels
- 500 W average power per panel with 7-16 DIN input
- Dual input allows for field adjustability of H/V ratio
- 4 standard azimuth patterns available
- Low VSWR, < 1.1:1 over operating band
- Aluminum construction
- ABS radome for environmental protection
- Custom azimuth and elevation patterns available upon request

Electrical Specifications – Individual Panel

Band	Polarization	VSWR	Input	Power Rating
UHF 470-806 MHz	Variable Elliptical Circular	1.1:1	Dual 7-16 DIN	500 W/Input

Mechanical Specifications – Individual Panel

Model	Height ft (m)	Weight lb (kg)	Wind Area ¹ ft ² (m ²)	Dimensions LxWxD (in)
TUM-LP UHF CP	3.2 (1.0)	40 (18.1)	6.8 (0.63)	38.25 x 18.25 x 8.10

¹ Wind area C_AA_C per TIA/EIA-222-F (C_A = 1.4)

Azimuth Patterns, TUM-LP UHF CP Antenna

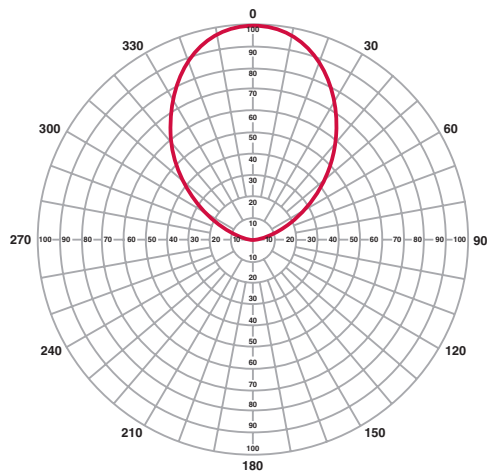

TUM-LP-C1
Azimuth gain=5.2

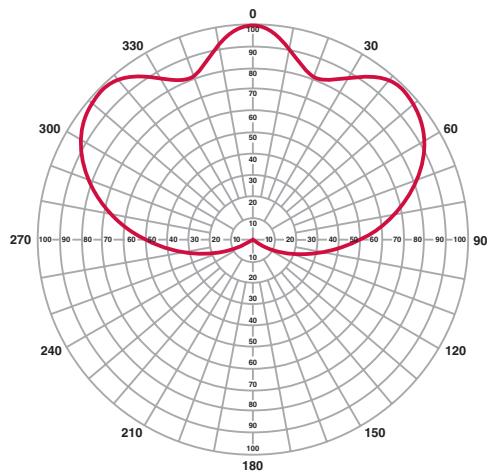

TUM-LP-C2
Azimuth gain=2.6

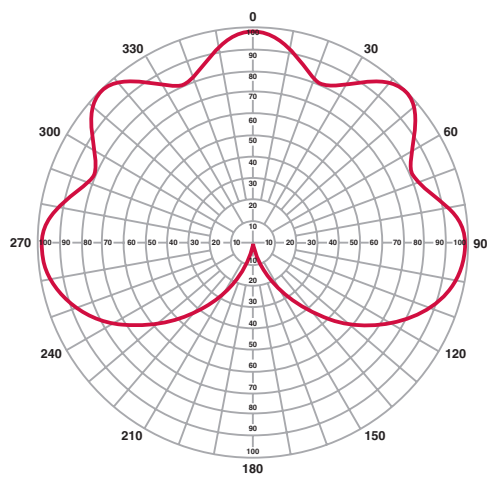

TUM-LP-C3
Azimuth gain=1.8

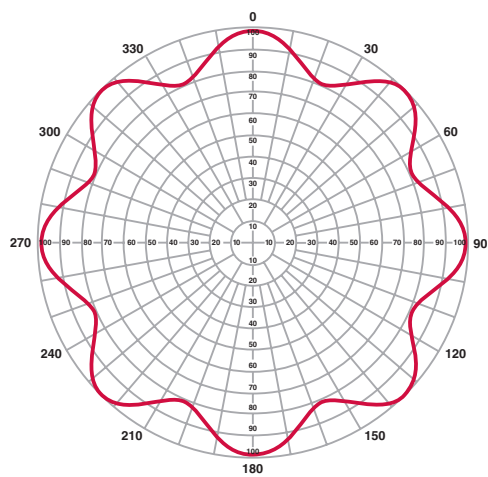

TUM-LP-O4
Azimuth gain=1.3

Notes:

1. Patterns shown are typical and calculated using a 24" square tower at 587 MHz. Specific gains and patterns will be supplied with the proposal.

Antenna Type	Azimuth Pattern	Layers	Peak Gain (ratio)	Peak Gain (dBd)	Weight lb (kg)	Avg. Power (kW)	Antenna Height ft (m)	$C_A A_C$ (CA=1.4) ft ² (m ²)
TUM-C1-1/1L	TUM-LP-C1	1	5.2	7.2	40.0 (18.2)	.5	3.2 (1.0)	6.8 (0.63)
TUM-C1-2/2L	TUM-LP-C1	2	11.5	10.6	91.8 (41.7)	1	6.8 (2.1)	15.4 (1.43)
TUM-C1-3/3L	TUM-LP-C1	3	17.7	12.5	134.1 (60.9)	1.5	10.4 (3.2)	23.1 (2.15)
TUM-C1-4/4L	TUM-LP-C1	4	23.4	13.7	177.2 (80.5)	2	13.9 (4.3)	31.2 (2.90)
TUM-C2-1/2L	TUM-LP-C2	2	2.6	4.2	91.8 (41.7)	1	3.2 (1.0)	13.3 (1.23)
TUM-C2-2/4L	TUM-LP-C2	2	5.7	7.6	175.4 (79.7)	2	6.8 (2.1)	26.3 (2.45)
TUM-C2-3/6L	TUM-LP-C2	3	8.9	9.5	260.8 (118.5)	3	10.4 (3.2)	40.1 (3.73)
TUM-C2-4/8L	TUM-LP-C2	4	11.7	10.7	348.0 (158.2)	4	13.9 (4.3)	54.6 (5.08)
TUM-C3-1/3L	TUM-LP-C3	1	1.8	2.6	132.7 (60.3)	1.5	3.2 (1.0)	17.4 (1.61)
TUM-C3-2/6L	TUM-LP-C3	2	4.0	6.0	258.1 (117.3)	3	6.8 (2.1)	34.9 (3.24)
TUM-C3-3/9L	TUM-LP-C3	3	6.1	7.9	386.2 (175.5)	4.5	10.4 (3.2)	53.5 (4.98)
TUM-C3-4/12L	TUM-LP-C3	4	8.1	9.1	537.0 (244.1)	6	13.9 (4.3)	75.3 (7.00)
TUM-O4-1/4L	TUM-LP-O4	1	1.3	1.1	173.6 (78.9)	2	3.2 (1.0)	21.5 (1.99)
TUM-O4-2/8L	TUM-LP-O4	2	2.9	4.6	340.8 (154.9)	4	6.8 (2.1)	43.4 (4.04)
TUM-O4-3/12L	TUM-LP-O4	3	4.4	6.4	531.6 (241.6)	6	10.4 (3.2)	68.9 (6.41)
TUM-O4-4/16L	TUM-LP-O4	4	5.9	7.7	706.0 (320.9)	8	13.9 (4.3)	93.9 (8.73)

- Peak gain is per polarization assuming full circular polarization
- For elliptical polarization, consult factory for peak gains
- Wind area $C_A A_C$ per TIA/EIA-222-F ($C_A = 1.4$)
- Weight excludes brackets and mounting hardware, includes typical feed system



Dielectric's TUA-M Series panel antenna is designed for broadband horizontally polarized operation.

Dielectric Advantages

- Operating Range: 470-860 MHz
- Horizontally polarized panel
- Economical broadband design
- A key building block for antennas with different azimuth and elevation patterns
- Suitable multiplexing many channels
- 1KW average power per panel with 7-16 DIN input
- 7 different standard azimuth patterns available
- Low VSWR, <1.1:1 over operating band
- Aluminum construction
- ABS radome for environmental protection
- Custom azimuth and elevation patterns available upon request

Electrical Specifications – Individual Panel

Band	Polarization	VSWR	Input	Power Rating
UHF 470-806 MHz	Horizontal	1.1:1	7-16 DIN	1KW/Input

Mechanical Specifications – Individual Panel

Model	Height ft (m)	Weight lb (kg)	Wind Area ¹ ft ² (m ²)	Dimensions LxWxD (in)
TUA-M	3.2 (1.0)	25 (11.4)	6.8 (0.63)	38.25 x 18.25 x 8.10

¹ Wind area $C_A A_C$ per TIA/EIA-222-F ($C_A = 1.4$)

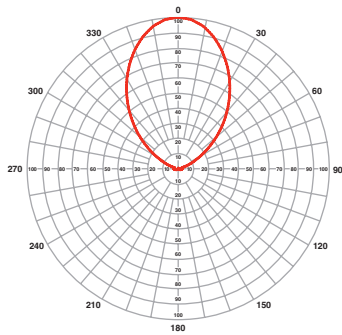

TUA-M-C1
Azimuth gain=6.0

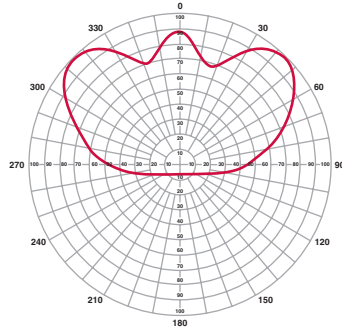

TUA-M-C2
Azimuth gain=2.9

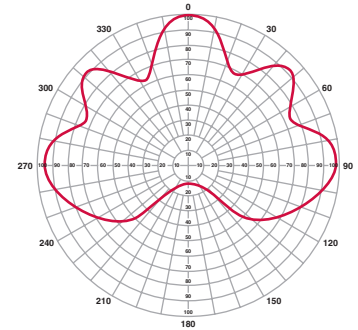

TUA-M-C3
Azimuth gain=1.9

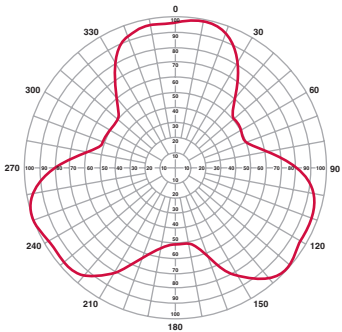

TUA-M-T3
Azimuth gain=1.6

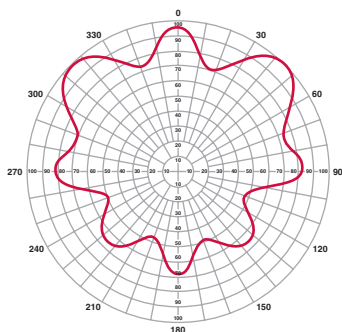

TUA-M-S4
Azimuth gain=1.9

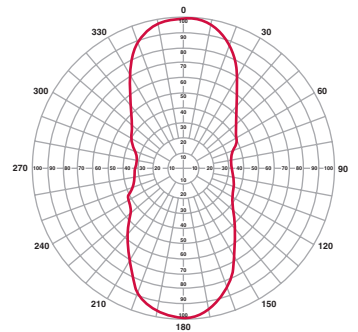

TUA-M-P4
Azimuth gain=2.5

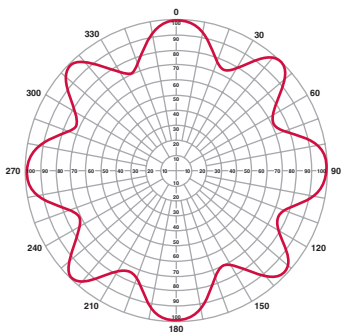

TUA-M-O4
Azimuth gain=1.3

Notes:

1. Patterns shown are typical and calculated using a 24" square tower at 587 MHz. Specific gains and patterns will be supplied with the proposal.

Antenna Type	Azimuth Pattern	Layers	Gain (ratio)	Peak Gain (dBd)	Weight lb (kg)	Avg. Power (kW)	Antenna Height ft (m)	C _A A _C (CA=1.4) ft ² (m ²)
TUA-C1-1/1M	TUA-M-C1	1	12.0	10.8	25.0 (11.4)	.5	3.2 (1.0)	6.8 (0.63)
TUA-C1-2/2M	TUA-M-C1	2	26.4	14.2	61.8 (28.1)	1	7.0 (2.1)	15.4 (1.43)
TUA-C1-3/3M	TUA-M-C1	3	40.8	16.1	89.1 (40.5)	1.5	10.8 (3.3)	23.1 (2.15)
TUA-C1-4/4M	TUA-M-C1	4	54.0	17.3	117.2 (53.3)	2	14.6 (4.5)	31.2 (2.90)
TUA-C2-1/2M	TUA-M-C2	1	5.8	7.6	61.8 (28.1)	2	3.2 (1.0)	13.3 (1.23)
TUA-C2-2/4M	TUA-M-C2	2	12.8	11.1	115.4 (52.5)	4	7.0 (2.1)	26.3 (2.45)
TUA-C2-3/6M	TUA-M-C2	3	19.7	12.9	170.8 (77.6)	6	10.8 (3.3)	40.1 (3.73)
TUA-C2-4/8M	TUA-M-C2	4	26.1	14.2	288.0 (103.6)	8	14.6 (4.5)	54.6 (5.08)
TUA-C3-1/3M	TUA-M-C3	1	3.8	5.8	87.7 (39.9)	2	3.2 (1.0)	17.4 (1.61)
TUA-C3-2/6M	TUA-M-C3	2	8.4	9.2	168.1 (76.4)	4	7.0 (2.1)	34.9 (3.24)
TUA-C3-3/9M	TUA-M-C3	3	12.9	11.1	251.2 (114.2)	6	10.8 (3.3)	53.5 (4.98)
TUA-C3-4/12M	TUA-M-C3	4	17.1	12.3	357.0 (162.3)	8	14.6 (4.5)	75.3 (7.00)
TUA-T3-1/4M	TUA-M-T3	1	3.2	5.1	87.7 (39.9)	1	3.2 (1.0)	15.5 (1.44)
TUA-T3-2/8M	TUA-M-T3	2	7.0	8.5	168.1 (76.4)	2	7.0 (2.1)	31.0 (2.89)
TUA-T3-3/12M	TUA-M-T3	3	10.9	10.4	251.2 (114.2)	3	10.8 (3.3)	47.8 (4.44)
TUA-T3-4/16M	TUA-M-T3	4	14.4	11.6	357.0 (162.3)	4	14.6 (4.5)	67.6 (6.29)
TUA-S4-1/4M	TUA-M-S4	1	3.8	5.8	113.6 (51.6)	1.5	3.2 (1.0)	21.5 (1.99)
TUA-S4-2/8M	TUA-M-S4	2	8.4	9.2	220.8 (100.4)	3	7.0 (2.1)	43.4 (4.04)
TUA-S4-3/12M	TUA-M-S4	3	12.9	11.1	351.6 (159.8)	4.5	10.8 (3.3)	68.9 (6.41)
TUA-S4-4/16M	TUA-M-S4	4	17.1	12.3	466.0 (211.8)	6	14.6 (4.5)	93.9 (8.73)
TUA-P4-1/4M	TUA-M-P4	1	5	7.0	113.6 (51.6)	2	3.2 (1.0)	21.5 (1.99)
TUA-P4-2/8M	TUA-M-P4	2	11.0	10.4	220.8 (100.4)	4	7.0 (2.1)	43.4 (4.04)
TUA-P4-3/12M	TUA-M-P4	3	17.0	12.3	351.6 (159.8)	6	10.8 (3.3)	68.9 (6.41)
TUA-P4-4/16M	TUA-M-P4	4	22.5	13.5	466.0 (211.8)	8	14.6 (4.5)	93.9 (8.73)
TUA-O4-1/4M	TUA-M-O4	1	2.6	4.1	113.6 (51.6)	1.5	3.2 (1.0)	21.5 (1.99)
TUA-O4-2/8M	TUA-M-O4	2	5.7	7.6	220.8 (100.4)	3	7.0 (2.1)	43.4 (4.04)
TUA-O4-3/12M	TUA-M-O4	3	8.8	9.5	351.6 (159.8)	4.5	10.8 (3.3)	68.9 (6.41)
TUA-O4-4/16M	TUA-M-O4	4	11.7	10.7	466.0 (211.8)	6	14.6 (4.5)	93.9 (8.73)

- Wind area C_AA_C per TIA/EIA-222-F (C_A = 1.4)
- Weight excludes brackets and mounting hardware, includes typical feed system



Dielectric's TFU-UT Series turnstile antenna is designed for broadband omni directional horizontally polarized operation. The TFU-UT features a simple feed system and durable construction. The internal bow tie design represents two batwings in a turnstile configuration, thereby eliminating one half of the feed lines normally needed to feed each radiator. The antenna design allows for dual inputs that have been developed for single channel or the simultaneous broadcast of two channels without the need for a combiner.

Dielectric Advantages

- Operating Range: 470-860 MHz
- Horizontally polarized
- Economical broadband design
- Self supporting: can be side or top mounted on tower
- Two inputs: 7-16 DIN and Type N
- Capable of combining two channels
- 1000 W average power into 7-16 DIN input
- 500 W average power into Type N input
- Low VSWR, < 1.15:1 over UHF band
- Aluminum construction
- ABS radome for environmental protection

Mechanical Specifications

Model	Height ft (m)	Weight lb (kg)	Windload ¹ ft ² (m ²)
TFU-UT	3.74 (1.14)	55 (25)	2.4 (0.22)

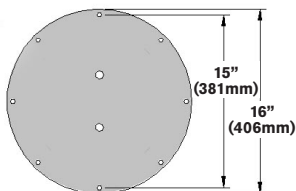
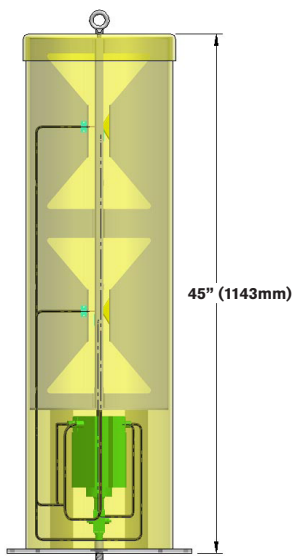

BASE FLANGE

¹ Windload at 50/33 lb/ft² per EIA RS-222-F

Electrical Specifications

Band	Polarization	VSWR	Input	Power Rating per input	Gain
UHF (470-860 MHz)	Horizontal	1.15:1	Dual 7-16 DIN Type N	1 kW 7-16 DIN 500 W Type N	5 dBd

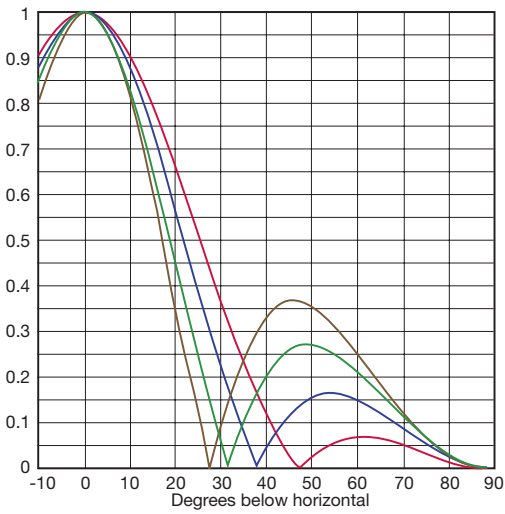

Elevation Pattern

500 MHz, 600 MHz, 700 MHz, 800 MHz

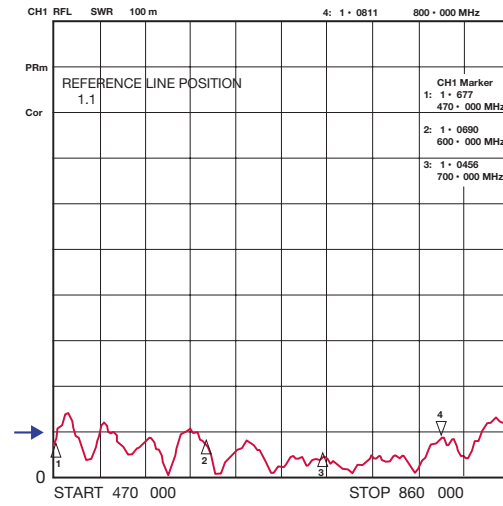

Measured VSWR

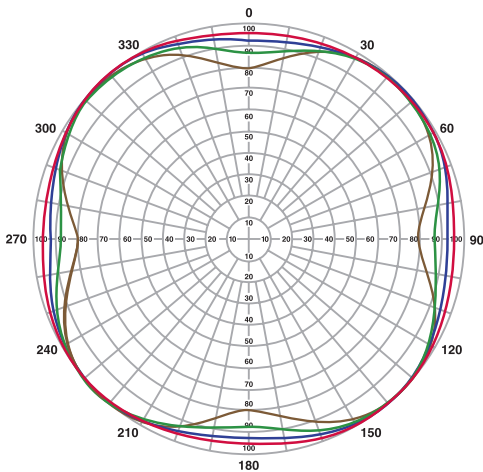

Azimuth Pattern

500 MHz, 600 MHz, 700 MHz, 800 MHz



The DCR-T antenna is a low power version of Dielectric's popular DCR Series FM antennas.

Dielectric Advantages

- Circularly polarized
- Branch feed
- Band tunable
- Ideal for Class A and B stations
- IBOC compatible
- Low VSWR, < 1.1:1 over operating channel (+/- 100kHz)
- 1 kW per bay power handling
- Light weight
- Easy Installation
- All aluminum construction
- Null fill and beam tilt available
- Bay input 7-16 DIN
- Standard array input 1 5/8" EIA
- 1 to 8 bays. Full wave or half wave spaced

Electrical Specifications

Band	Polarization	Circularity	VSWR	Input	Power Rating
FM 88-108 MHz	Circular	± 1 dB Free space	w/o field trim 1.2:1 Top mounted 1.5:1 Side mounted with field trim 1.07:1 (± 100 kHz)	Bay 7-16 DIN Array 1 5/8" EIA	500 W/Input

Mechanical Specifications – Individual Bay

Height in (m)	Diameter in (m)	Weight lb (kg)	Wind Area ¹ ft ² (m ²)
20 (0.503)	20.7 (0.526)	175 (8.0)	2.4 (2.2)

¹ Wind area (C_AA_C) is calculated per the TIA/EIA-222-F standard

Antenna Type	# of Bays	RMS Gain full wave spaced (ratio)	RMS Gain full wave spaced (dBd)	RMS Gain half wave spaced (ratio)	RMS Gain half wave spaced (dBd)	Weight full wave spaced lb (kg)	Weight half wave spaced lb (kg)	Wind Area full wave spaced ¹ ft ² (m ²)	Wind Area half wave spaced ¹ ft ² (m ²)	Power rating kW
DCRT1	1	0.46	-3.37	0.46	-3.37	17.5 (8.0)	17.5 (8.0)	2.4 (0.22)	2.4 (0.22)	1
DCRT2	2	1	0	0.7	-1.55	47.4 (21.5)	46.5 (21.1)	6.0 (0.56)	5.7 (0.53)	2
DCRT3	3	1.5	1.76	1	0	67.9 (30.9)	66.1 (30.0)	9.4 (0.87)	8.8 (0.82)	3
DCRT4	4	2.1	3.22	1.2	0.79	90.2 (40.1)	56.0 (39.1)	13.3 (1.24)	12.0 (1.11)	4
DCRT5	5	2.7	4.31	1.5	1.76	114.0 (51.8)	106.5 (48.4)	17.8 (1.65)	15.4 (1.43)	5
DCRT6	6	3.2	5.05	1.8	2.55	145.8 (66.3)	142.2 (64.6)	20.3 (1.89)	18.8 (1.74)	6
DCRT7	7	3.8	5.8	2.1	3.22	168.3 (76.5)	162.0 (73.6)	24.6 (2.29)	22.0 (2.04)	7
DCRT8	8	4.3	6.34	2.3	3.62	190.4 (82.7)	182.0 (82.7)	28.7 (2.67)	25.3 (2.35)	8

Notes:

- Wind area ($C_A A_C$) is calculated per the TIA/EIA-222-F standard
- RMS gain are for midband and include feed system losses. Actual gain will vary depending on feed systems, frequency, null fill and beam tilt
- $C_A A_C$ include bays, power dividers, inter-bay feed lines and standard brackets for mounting

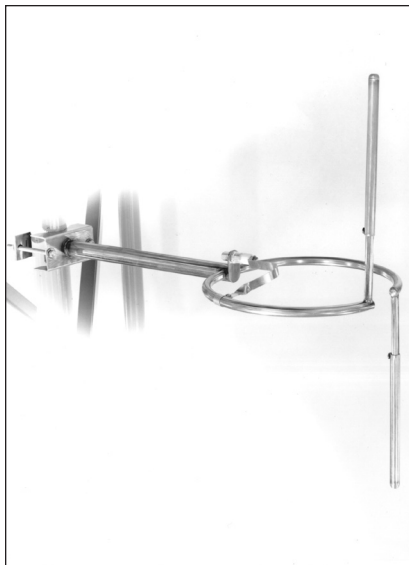

The DCR-L antenna is intended for the low power broadcaster.

Dielectric Advantages

- Circularly polarized
- Branch feed
- Pressurization not required
- 500W single bay power handling
- Very low weight and windload
- Easy Installation
- Stainless steel construction
- Null fill and beam tilt available
- Bay input type N
- Integral mount designed to attach to a tower leg or pole 1" to 3 1/2" in diameter

Electrical Specifications

Band	Polarization	VSWR	Input	Power Rating
FM 88-108 MHz	Circular	w/o field trim 1.2:1 Top mounted 1.5:1 Side mounted with field trim 1.07:1 (± 100 kHz)	Type N Single Bay 7-16 DIN Array	500 W Single Bay 1kW Array

¹ Wind area ($C_A A_C$) is calculated per the TIA/EIA-222-F standard

Antenna Type	# of Bays	RMS Gain full wave spaced (ratio)	RMS Gain full wave spaced (dBd)	RMS Gain half wave spaced (ratio)	RMS Gain half wave spaced (dBd)	Weight lb (kg)	Wind Area ft ² (m ²)	With radome Weight lb (kg)	With radome Wind Area ft ² (m ²)	Power rating kW
DCRL1	1	0.46	-3.37	0.46	-3.37	8 (4)	1.1 (0.2)	18 (8)	3.2 (0.4)	1
DCRL2	2	1	0	0.7	-1.55	31 (14)	2.7 (0.2)	176 (80)	6.3 (0.5)	1
DCRL3	3	1.5	1.76	1	0	39 (18)	3.8 (0.4)	264 (120)	9.5 (0.9)	1
DCRL4	4	2.1	3.22	1.2	0.79	47 (21.0)	4.9 (0.5)	352 (160)	12.6 (1.3)	1
DCRL6	6	3.2	5.05	1.8	2.55	63 (29)	7.0 (0.7)	528 (240)	19.1 (1.8)	1

Notes:

- Wind area ($C_A A_C$) is calculated per the TIA/EIA-222-F standard
- RMS gain are for midband and include feed system losses. Actual gain will vary depending on feed systems, frequency, null fill and beam tilt
- $C_A A_C$ include bays, power dividers, and standard brackets for mounting brackets. Excludes feed system.

Dielectric POWERLITE™ Series 100W Tunable Bandpass Filter

- Not temperature compensated
- For indoor applications
- For 6 MHz channel bandwidths in analog TV, digital TV and mobile media applications
- ATSC full mask, ATSC stringent mask, and ISDB-T non-critical mask

Specifications

Model Number	UT6E2F-100		
Mask	ATSC Full Mask	ATSC Stringent Mask	ISDB-T Non-Critical Mask
Maximum Input Power	100 Watts		
Frequency	470-806 MHz		
Channel BW	6 MHz		
Insertion Loss			
Band Center	1.3 dB	1.3 dB	1.3 dB
Band Edge	2.2 dB (+/-2.69 MHz)	2.2 dB (+/-2.69 MHz)	2.2 dB (+/-2.79 MHz)
Attenuation			
+/- 3.50 MHz	≥ 2.5 dB	≥ 5 dB	NA
+/- 4.50 MHz	≥ 14 dB	≥ 23 dB	≥ 19 dB
+/- 6.0 MHz	≥ 33 dB	≥ 33 dB	NA
+/- 9.0 MHz	≥ 64 dB	NA	≥ 53 dB
Group Delay Variation	< 150 nS	< 200 nS	< 200 nS
VSWR/RL	1.17:1/22.1 dB (+/-2.69 MHz)	1.17:1/22.1 dB (+/-2.69 MHz)	1.17:1/22.1 dB (+/-2.79 MHz)
Ambient Temperature	32°F(0°C) to 113°F(+45°C)		
Storage Temperature	14°F(-10°C) to 131°F(+55°C)		
Connectors In/Out	Type N Female		
Humidity	<95% Non-Condensing		
Altitude	3048 m (10000')		
Dimensions (LxWxH)	318 mm X 115 mm X 204 mm (12.5" X 4.5" X 8")		
Weight	3 kg / 6.6 lb		
No Sections	6		
Transmission Zeros	2		

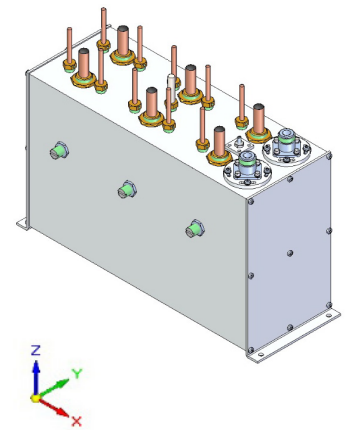

Dielectric POWERLITE™ Series 130W Tunable Bandpass Filter



- For indoor applications
- For 6, 7 and 8 MHz channel bandwidths in analog TV, digital TV and mobile media applications
- DVB-T non-critical mask
- Temperature compensated

Specifications

Model Number	UT6D2F-130		
Mask	DVB-T Non-Critical	DVB-T Non-Critical	DVB-T2/EXT Non-Critical
Maximum Input Power	130 Watts		
Frequency	470-862 MHz		
Channel BW	6 MHz	7 MHz	8 MHz
Insertion Loss			
Band Center	1.2 dB	1.0 dB	1.0 dB
Band Edge	2.9 dB (+/-2.86 MHz)	2.4 dB (+/-3.40 MHz)	2.0 dB (+/-3.80 MHz) 2.2 dB (+/-3.90 MHz) Ext.
Attenuation			
+/- 3.20/3.70/NA MHz	≥ 5.0 dB	≥ 3.5 dB	NA
+/- 4.50/5.25/4.20 MHz	≥ 18 dB	≥ 18 dB	≥ 4.0 dB
+/- 9.0/10.5/6.0 MHz	≥ 40 dB	≥ 43 dB	≥ 18 dB
+/-12.0/12.0/12.0 MHz	≥ 55 dB	≥ 55 dB	≥ 44 dB
Group Delay Variation	< 400 nS	< 350 nS	< 350 nS
VSWR/RL	1.17:1/22.1 dB (+/-2.86 MHz)	1.17:1/22.1 dB (+/-3.40 MHz)	1.17:1/22.1 dB (+/-3.90 MHz)
Ambient Temperature	32°F(0°C) to 113°F(+45°C)		
Storage Temperature	14°F(-10°C) to 131°F(+55°C)		
Connectors In/Out	Type N Female		
Humidity	<95% Non-Condensing		
Altitude	3048 m (10000')		
Dimensions (LxWxH)	318 mm X 115 mm X 204 mm (12.5" X 4.5" X 8")		
Weight	3 kg / 6.6 lb		
No Sections	6		
Transmission Zeros	4		

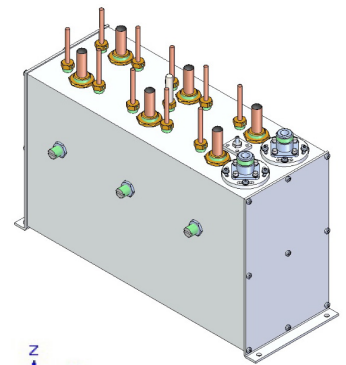

Dielectric POWERLITE™ Series 130W Tunable Bandpass Filter

- For indoor applications
- Temperature compensated
- For 6, 7 and 8 MHz channel bandwidths in analog TV, digital TV and mobile media applications
- DVB-T non-critical mask

Specifications

Model Number	UT8D2F-130		
Mask	DVB-T Critical	DVB-T Critical	DVB-T2/EXT Critical
Maximum Input Power	130 Watts		
Frequency	470-860 MHz		
Channel BW	6 MHz	7 MHz	8 MHz
Insertion Loss			
Band Center	1.3 dB	1.2 dB	1.2 dB
Band Edge	4.9 dB (+/-2.86 MHz)	4.8 dB (+/-3.40 MHz)	4.4 dB (+/-3.80 MHz) 4.9 dB (+/-3.90 MHz) Ext.
Attenuation			
+/- 3.20/3.70/NA MHz	≥ 15 dB	≥ 15 dB	NA
+/- 4.50/5.25/4.20 MHz	≥ 28 dB	≥ 28 dB	≥ 15 dB
+/- 9.0/10.5/6.0 MHz	≥ 55 dB	≥ 53 dB	≥ 28 dB
+/-12.0/12.0/12.0 MHz	≥ 60 dB	≥ 60 dB	≥ 55 dB
Group Delay Variation	< 700 nS	< 700 nS	< 700 nS
VSWR/RL	1.17:1/22.1 dB (+/-2.86 MHz)	1.17:1/22.1 dB (+/-3.40 MHz)	1.17:1/22.1 dB (+/-3.90 MHz)
Ambient Temperature	0°C to 45°C (32°F to 113°F)		
Storage Temperature	-10°C to 55°C (14°F to 131°F)		
Connectors In/Out	Type N Female		
Humidity	<95% Non-Condensing		
Altitude	3048 m (10000')		
Dimensions (LxWxH)	419 mm X 115 mm X 204 mm (16.5" X 4.5" X 8")		
Weight	4 kg / 8.5 lb		
No Sections	8		
Transmission Zeros	4		

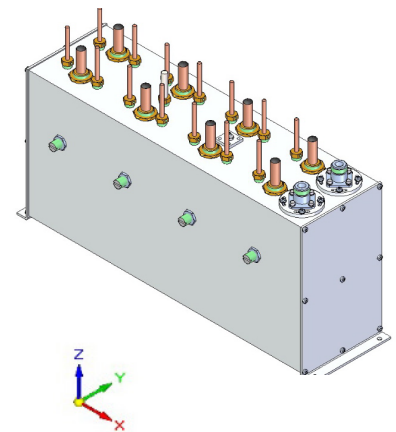

- Not temperature compensated
- For indoor applications
- For 6 MHz channel bandwidths in analog TV, digital TV and mobile media applications
- ATSC full mask, ATSC stringent mask, and ISDB-T non-critical mask

Specifications

Model Number	UT6E2F-150		
Mask	ATSC Full Mask	ATSC Stringent Mask	ISDB-T Non-Critical Mask
Maximum Input Power	150 Watts		
Frequency	470-806 MHz		
Channel BW	6 MHz		
Insertion Loss			
Band Center	1.1 dB	1.1 dB	1.1 dB
Band Edge	2.0 dB (+/-2.69 MHz)	2.0 dB (+/-2.69 MHz)	2.0 dB (+/-2.79 MHz)
Attenuation			
+/- 3.50 MHz	≥ 2.5 dB	≥ 5 dB	NA
+/- 4.50 MHz	≥ 14 dB	≥ 23 dB	≥ 19 dB
+/- 6.0 MHz	≥ 33 dB	≥ 33 dB	NA
+/- 9.0 MHz	≥ 64 dB	NA	≥ 53 dB
Group Delay Variation	< 150 nS	< 200 nS	< 200 nS
VSWR/RL	1.17:1/22.1 dB (+/-2.69 MHz)	1.17:1/22.1 dB (+/-2.69 MHz)	1.17:1/22.1 dB (+/-2.79 MHz)
Ambient Temperature	32°F(0°C) to 113°F(+45°C)		
Storage Temperature	14°F(-10°C) to 131°F(+55°C)		
Connectors In/Out	Type N Female		
Humidity	<95% Non-Condensing		
Altitude	3048 m (10000')		
Dimensions (LxWxH)	318 mm X 115 mm X 204 mm (12.5" X 4.5" X 8")		
Weight	3 kg / 6.6 lb		
No Sections	6		
Transmission Zeros	2		

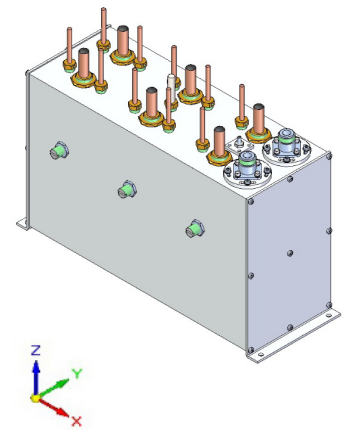

Dielectric POWERLITE™ Series 250W Tunable Bandpass Filter

- For indoor applications
- For 6, 7 and 8 MHz channel bandwidths in analog TV, digital TV and mobile media applications
- DVB-T non-critical mask
- Temperature compensated

Specifications

Model Number	UT6D3F-250		
Mask	DVB-T Non-Critical	DVB-T Non-Critical	DVB-T2/EXT Non-Critical
Maximum Input Power	250 Watts		
Frequency	470-862 MHz		
Channel BW	6 MHz	7 MHz	8 MHz
Insertion Loss			
Band Center	1.15 dB	1.0 dB	1.0 dB
Band Edge	2.7 dB (+/-2.86 MHz)	2.2 dB (+/-3.40 MHz)	1.8 dB (+/-3.80 MHz) 2.0 dB (+/-3.90 MHz) Ext.
Attenuation			
+/- 3.20/3.70/NA MHz	≥ 3.0 dB	≥ 3.5 dB	NA
+/- 4.50/5.25/4.20 MHz	≥ 18 dB	≥ 18 dB	≥ 4.0 dB
+/- 9.0/10.5/6.0 MHz	≥ 40 dB	≥ 43 dB	≥ 18 dB
+/-12.0/12.0/12.0 MHz	≥ 58 dB	≥ 55 dB	≥ 44 dB
Group Delay Variation	< 400 nS	< 350 nS	< 350 nS
VSWR/RL	1.17:1/22.1 dB (+/-2.86 MHz)	1.17:1/22.1 dB (+/-3.40 MHz)	1.17:1/22.1 dB (+/-3.90 MHz)
Ambient Temperature	0°C to 45°C (32°F to 113°F)		
Storage Temperature	-10°C to 55°C (14°F to 131°F)		
Connectors In/Out	Type N Female		
Humidity	<95% Non-Condensing		
Altitude	3048 m (10000')		
Dimensions (LxWxH)	318 mm X 115 mm X 204 mm (12.5" X 4.5" X 8")		
Weight	3 kg / 6.6 lb		
No Sections	6		
Transmission Zeros	4		

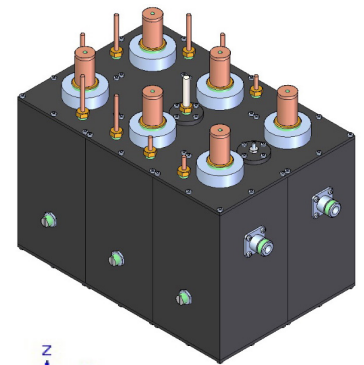

Dielectric POWERLITE™ Series 250W Tunable Bandpass Filter

- For indoor applications
- For 6 MHz channel bandwidths in analog TV, digital TV and mobile media applications
- ATSC full mask, ATSC stringent mask, and ISDB-T non-critical mask
- Temperature compensated

Specifications

Model Number	UT6E2F-250		
Mask	ATSC Full Mask	ATSC Stringent Mask	ISDB-T Non-Critical Mask
Maximum Input Power	250 Watts		
Frequency	470-806 MHz		
Channel BW	6 MHz		

Insertion Loss

Band Center	1.15 dB	1.1 dB	1.1 dB
Band Edge	1.8 dB (+/-2.69 MHz)	1.8 dB (+/-2.69 MHz)	1.8 dB (+/-2.79 MHz)

Attenuation

+/- 3.50 MHz	≥ 2.5 dB	≥ 5 dB	NA
+/- 4.50 MHz	≥ 14 dB	≥ 23 dB	≥ 19 dB
+/- 6.0 MHz	≥ 33 dB	≥ 33 dB	NA
+/- 9.0 MHz	≥ 64 dB	NA	≥ 53 dB

Group Delay Variation	< 150 nS	< 200 nS	< 200 nS
VSWR/RL	1.17:1/22.1 dB (+/-2.69MHz)	1.17:1/22.1 dB (+/-2.69MHz)	1.17:1/22.1 dB (+/-2.79MHz)
Ambient Temperature	0°C to 45°C (32°F to 113°F)		
Storage Temperature	-10°C to 55°C (14°F to 131°F)		
Connectors In/Out	Type N Female		
Humidity	<95% Non-Condensing		
Altitude	3048 m (10000')		
Dimensions (LxWxH)	318 mm X 115 mm X 204 mm (12.5" X 4.5" X 8")		
Weight	3 kg / 6.6 lb		
No Sections	6		
Transmission Zeros	2		

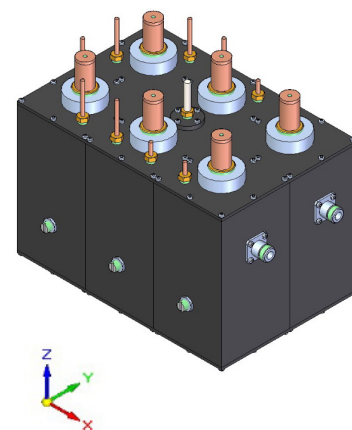

Dielectric POWERLITE™ Series 250W Tunable Bandpass Filter

- For indoor applications
- Temperature compensated
- For 6, 7 and 8 MHz channel bandwidths in analog TV, digital TV and mobile media applications
- DVB-T critical mask

Specifications

Model Number	UT8D2F-250		
Mask	DVB-T Critical	DVB-T Critical	DVB-T2/EXT Critical
Maximum Input Power	250 Watts		
Frequency	470-860 MHz		
Channel BW	6 MHz	7 MHz	8 MHz
Insertion Loss			
Band Center	1.5 dB	1.3 dB	1.2dB
Band Edge	4.9 dB (+/-2.86 MHz)	4.5 dB (+/-3.40 MHz)	4.0 dB (+/-3.80 MHz) 4.5 dB (+/-3.90 MHz) Ext.
Attenuation			
+/- 3.20/3.70/NA MHz	≥ 15 dB	≥ 15 dB	NA
+/- 4.50/5.25/4.20 MHz	≥ 28 dB	≥ 28 dB	≥ 15 dB
+/- 9.0/10.5/6.0 MHz	≥ 55 dB	≥ 53 dB	≥ 28 dB
+/-12.0/12.0/12.0 MHz	≥ 60 dB	≥ 60 dB	≥ 55 dB
Group Delay Variation	<700 nS	< 700 nS	< 700 nS
VSWR/RL	1.17:1/22.1 dB (+/-2.86 MHz)	1.17:1/22.1 dB (+/-3.40 MHz)	1.17:1/22.1 dB (+/-3.90 MHz)
Ambient Temperature	0°C to 45°C (32°F to 113°F)		
Storage Temperature	-10°C to 55°C (14°F to 131°F)		
Connectors In/Out	Type N Female		
Humidity	<95% Non-Condensing		
Altitude	3048 m (10000')		
Dimensions (LxWxH)	419 mm X 115 mm X 204 mm (16.5" X 4.5" X 8")		
Weight	6 kg / 13 lb		
No Sections	8		
Transmission Zeros	4		

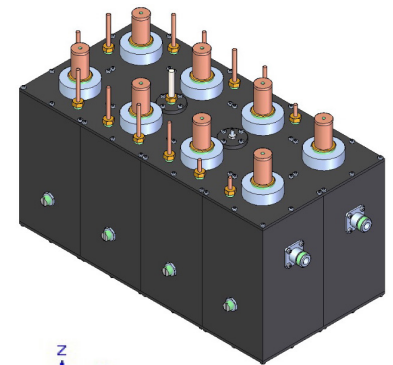

Dielectric POWERLITE™ Series 600W Tunable Bandpass Filter

- For indoor applications
- Temperature compensated
- For 6, 7 and 8 MHz channel bandwidths in analog TV, digital TV and mobile media applications
- DVB-T non-critical mask

Specifications

Model Number	UT6D4F-600		
Mask	DVB-T Non-Critical	DVB-T Non-Critical	DVB-T2/EXT Non-Critical
Maximum Input Power	600 Watts		
Frequency	470-860 MHz		
Channel BW	6 MHz	7 MHz	8 MHz
Insertion Loss			
Band Center	1.2 dB	1.1 dB	1.1 dB
Band Edge	2.2 dB (+/-2.86 MHz)	2.0 dB (+/-3.40 MHz)	1.7 dB (+/-3.80 MHz) 1.9 dB (+/-3.90 MHz) Ext.
Attenuation			
+/- 3.20/3.70/NA MHz	≥ 3.0 dB	≥ 3.5 dB	NA
+/- 4.50/5.25/4.20 MHz	≥ 18 dB	≥ 18 dB	≥ 4.0 dB
+/- 9.0/10.5/6.0 MHz	≥ 40 dB	≥ 43 dB	≥ 18 dB
+/-12.0/12.0/12.0 MHz	≥ 58 dB	≥ 55 dB	≥ 44 dB
Group Delay Variation	< 400 nS	< 350 nS	< 350 nS
VSWR/RL	1.15:1/23.1 dB (+/-2.86 MHz)	1.15:1/23.1 dB (+/-3.40 MHz)	1.15:1/23.1 dB (+/-3.90 MHz)
Ambient Temperature	0°C to 45°C (32°F to 113°F)		
Storage Temperature	-10°C to 55°C (14°F to 131°F)		
Connectors In/Out	7/16 DIN Female		
Humidity	<95% Non-Condensing		
Altitude	3048 m (10000')		
Dimensions (LxWxH)	370 mm X 254 mm X 204 mm (14.5" X 10.0" X 8")		
Weight	6 kg / 13 lb		
No Sections	6		
Transmission Zeros	4		

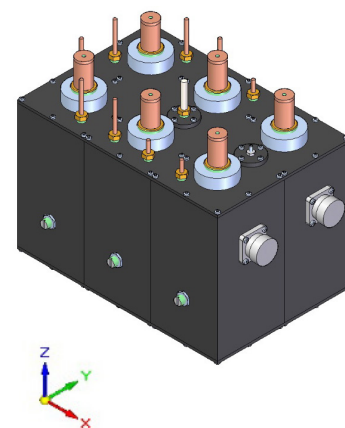

Dielectric POWERLITE™ Series 600W Tunable Bandpass Filter

- For indoor applications
- For 6 MHz channel bandwidths in analog TV, digital TV and mobile media applications
- ATSC full mask, ATSC stringent mask, and ISDB-T non-critical mask
- Temperature compensated

Specifications

Model Number	UT6E4F-600		
Mask	ATSC Full Mask	ATSC Stringent Mask	ISDB-T Non-Critical Mask
Maximum Input Power	600 Watts		
Frequency	470-806 MHz		
Channel BW	6 MHz		
Insertion Loss			
Band Center	1.2 dB	1.2 dB	1.2 dB
Band Edge	2.0 dB (+/-2.69 MHz)	2.0 dB (+/-2.69 MHz)	2.0 dB (+/-2.79 MHz)
Attenuation			
+/- 3.50 MHz	≥ 2.5 dB	≥ 5 dB	NA
+/- 4.50 MHz	≥ 14 dB	≥ 23 dB	≥ 19 dB
+/- 6.0 MHz	≥ 33 dB	≥ 33 dB	NA
+/- 9.0 MHz	≥ 64 dB	NA	≥ 53 dB
Group Delay Variation	< 150 nS	< 200 nS	< 200 nS
VSWR/RL	1.15:1/23.1 dB (+/-2.69MHz)	1.15:1/23.1 dB (+/-2.69MHz)	1.15:1/23.1 dB (+/-2.79MHz)
Ambient Temperature	0°C to 45°C (32°F to 113°F)		
Storage Temperature	-10°C to 55°C (14°F to 131°F)		
Connectors In/Out	7/16 DIN Female		
Humidity	<95% Non-Condensing		
Altitude	3048 m (10000')		
Dimensions (LxWxH)	370 mm X 254 mm X 204 mm (14.5" X 10.0" X 8")		
Weight	6 kg / 13 lb		
No Sections	6		
Transmission Zeros	2		

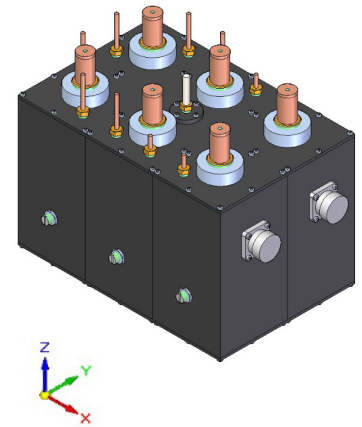

- For indoor applications
- Temperature compensated
- For 6, 7 and 8 MHz channel bandwidths in analog TV, digital TV and mobile media applications
- DVB-T critical mask

Specifications

Model Number	UT8D4F-500		
Mask	DVB-T Critical	DVB-T Critical	DVB-T2/EXT Critical
Maximum Input Power	500 Watts		
Frequency	470-860 MHz		
Channel BW	6 MHz	7 MHz	8 MHz
Insertion Loss			
Band Center	1.4 dB	1.2 dB	1.1 dB
Band Edge	3.0 dB (+/-2.86 MHz)	4.4 dB (+/-3.40 MHz)	3.5 dB (+/-3.80 MHz) 4.1 dB (+/-3.90 MHz) Ext.
Attenuation			
+/- 3.20/3.70/NA MHz	≥ 15 dB	≥ 15 dB	NA
+/- 4.50/5.25/4.20 MHz	≥ 28 dB	≥ 28 dB	≥ 15 dB
+/- 9.0/10.5/6.0 MHz	≥ 55 dB	≥ 53 dB	≥ 28 dB
+/-12.0/12.0/12.0 MHz	≥ 60 dB	≥ 60 dB	≥ 55 dB
Group Delay Variation	<700 nS	< 700 nS	< 700 nS
VSWR/RL	1.15:1/23.1 dB (+/-2.86 MHz)	1.15:1/23.1 dB (+/-3.40 MHz)	1.15:1/23.1 dB (+/-3.90 MHz)
Ambient Temperature	0°C to 45°C (32°F to 113°F)		
Storage Temperature	-10°C to 55°C (14°F to 131°F)		
Connectors In/Out	7/16 DIN Female		
Humidity	<95% Non-Condensing		
Altitude	3048 m (10000')		
Dimensions (LxWxH)	483 mm X 254 mm X 204 mm (19"X 10.0" X 8")		
Weight	7 kg / 15 lb		
No Sections	8		
Transmission Zeros	4		

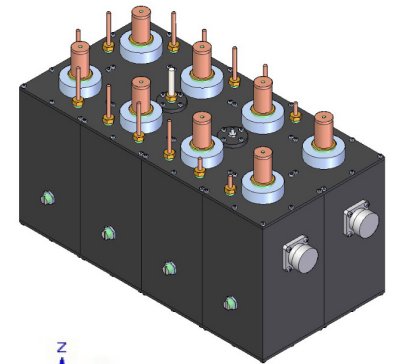

Dielectric POWERLITE™ Series 1.5kW Tunable Bandpass Filter

- For indoor applications
- Temperature compensated
- For 6, 7 and 8 MHz channel bandwidths in analog TV, digital TV and mobile media applications
- DVB-T non-critical mask

Specifications

Model Number	UT6D7F-1.5K		
Mask	DVB-T Non-Critical	DVB-T Non-Critical	DVB-T2/EXT Non-Critical
Maximum Input Power	1500 Watts		
Frequency	470-860 MHz		
Channel BW	6 MHz	7 MHz	8 MHz
Insertion Loss			
Band Center	0.6 dB	0.5 dB	0.5 dB
Band Edge	1.1 dB (+/-2.86 MHz)	1.0 dB (+/-3.40 MHz)	1.0 dB (+/-3.80 MHz) 1.1 dB (+/-3.90 MHz) Ext.
Attenuation			
+/- 3.20/3.70/NA MHz	≥ 3.0 dB	≥ 3.5 dB	NA
+/- 4.50/5.25/4.20 MHz	≥ 18 dB	≥ 18 dB	≥ 4.0 dB
+/- 9.0/10.5/ 6.0 MHz	≥ 40 dB	≥ 43 dB	≥ 18 dB
+/- 12.0/12.0/12.0 MHz	≥ 55 dB	≥ 55 dB	≥ 44 dB
Group Delay Variation	< 400 nS	< 350 nS	< 350 nS
VSWR/RL	1.12:1/24.9 dB (+/-2.86 MHz)	1.12:1/24.9 dB (+/-3.40 MHz)	1.12:1/24.9 dB (+/-3.90 MHz)
Ambient Temperature	0°C to 45°C (32°F to 113°F)		
Storage Temperature	-10°C to 55°C (14°F to 131°F)		
Connectors In/Out	1 5/8 EIA		
Humidity	<95% Non-Condensing		
Altitude	3048 m (10000')		
Dimensions (LxWxH)	597 mm X 381 mm X 178 mm (23.25"X 15" X 7")		
Weight	20.5 kg / 45 lb		
No Sections	6		
Transmission Zeros	4		

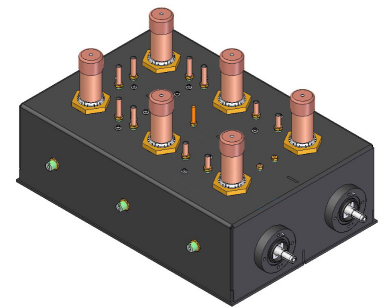

Dielectric POWERLITE™ Series 1.5kW Tunable Bandpass Filter

- For indoor applications
- For 6 MHz channel bandwidths in analog TV, digital TV and mobile media applications
- ATSC full mask, ATSC stringent mask, and ISDB-T non-critical mask
- Temperature compensated

Specifications

Model Number	UT6E7F-1.5K		
Mask	ATSC Full Mask	ATSC Stringent Mask	ISDB-T Non-Critical Mask
Maximum Input Power	1500 Watts		
Frequency	470-806 MHz		
Channel BW	6 MHz		
Insertion Loss			
Band Center	0.6 dB	0.6 dB	0.6 dB
Band Edge	1.1 dB (+/-2.69 MHz)	1.1 dB (+/-2.69 MHz)	1.1 dB (+/-2.79 MHz)
Attenuation			
+/- 3.50 MHz	≥ 1.5 dB	≥ 5 dB	NA
+/- 4.50 MHz	≥ 14 dB	≥ 23 dB	≥ 19 dB
+/- 6.0 MHz	≥ 33 dB	≥ 33 dB	NA
+/- 9.0 MHz	≥ 64 dB	NA	≥ 53 dB
Group Delay Variation	< 150 nS	< 200 nS	< 200 nS
VSWR/RL	1.12:1/24.9 dB (+/-2.69MHz)	1.12:1/24.9 dB (+/-2.69MHz)	1.12:1/24.9 dB (+/-2.79MHz)
Ambient Temperature	0°C to 45°C (32°F to 113°F)		
Storage Temperature	-10°C to 55°C (14°F to 131°F)		
Connectors In/Out	1 5/8 EIA		
Humidity	<95% Non-Condensing		
Altitude	3048 m (10000')		
Dimensions (LxWxH)	597 mm X 381 mm X 178 mm (23.25" X 15" X 7")		
Weight	20.5 kg / 45 lb		
No Sections	6		
Transmission Zeros	2		

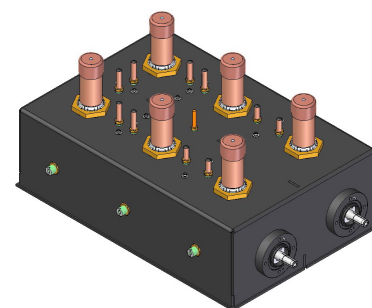

Dielectric POWERLITE™ Series 1.5kW Tunable Bandpass Filter

- For indoor applications
- Temperature compensated
- For 6, 7 and 8 MHz channel bandwidths in analog TV, digital TV and mobile media applications
- DVB-T critical mask

Specifications

Model Number	UT8D7F-1.5K		
Mask	DVB-T Critical	DVB-T Critical	DVB-T2/EXT Critical
Maximum Input Power	1500 Watts		
Frequency	470-860 MHz		
Channel BW	6 MHz	7 MHz	8 MHz
Insertion Loss			
Band Center	0.8 dB	0.7 dB	0.7 dB
Band Edge	2.4 dB (+/-2.86 MHz)	2.0 dB (+/-3.40 MHz)	1.6 dB (+/-3.80 MHz) 2.0 dB (+/-3.90 MHz) Ext.
Attenuation			
+/- 3.20/3.70/NA MHz	≥ 15 dB	≥ 15 dB	NA
+/- 4.50/5.25/4.20 MHz	≥ 28 dB	≥ 28 dB	≥ 15 dB
+/- 9.0/10.5/ 6.0 MHz	≥ 55 dB	≥ 53 dB	≥ 28 dB
+/- 12.0/12.0/12.0 MHz	≥ 60 dB	≥ 60 dB	≥ 55 dB
Group Delay Variation	<700 nS	< 700 nS	< 700 nS
VSWR/RL	1.12:1/24.9 dB (+/-2.86 MHz)	1.12:1/24.9 dB (+/-3.40 MHz)	1.12:1/24.9 dB (+/-3.90 MHz)
Ambient Temperature	0°C to 45°C (32°F to 113°F)		
Storage Temperature	-10°C to 55°C (14°F to 131°F)		
Connectors In/Out	1 5/8 EIA		
Humidity	<95% Non-Condensing		
Altitude	3048 m (10000')		
Dimensions (LxWxH)	770 mm X 381 mm X 178 mm (30.25" X 15" X 7")		
Weight	26.5 kg / 60 lb		
No Sections	8		
Transmission Zeros	4		

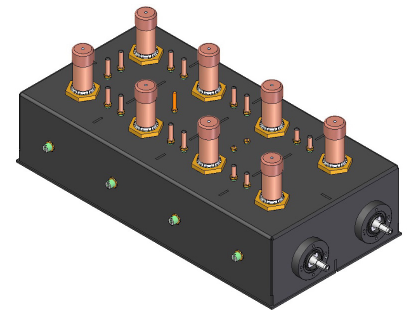

Dielectric POWERLITE™ Series 3kW Tunable Bandpass Filter

- For indoor applications
- Temperature compensated
- For 6, 7 and 8 MHz channel bandwidths in analog TV, digital TV and mobile media applications
- DVB-T non-critical mask

Specifications

Model Number	UT6D7F-3K		
Mask	DVB-T Non-Critical	DVB-T Non-Critical	DVB-T2/EXT Non-Critical
Maximum Input Power	3000 Watts		
Frequency	470-860 MHz		
Channel BW	6 MHz	7 MHz	8 MHz
Insertion Loss			
Band Center	0.6 dB	0.5 dB	0.5 dB
Band Edge	1.1 dB (+/-2.86 MHz)	1.0 dB (+/-3.40 MHz)	1.0 dB (+/-3.80 MHz) 1.1 dB (+/-3.90 MHz) Ext.
Attenuation			
+/- 3.20/3.70/NA MHz	≥ 3.0 dB	≥ 3.5 dB	NA
+/- 4.50/5.25/4.20 MHz	≥ 18 dB	≥ 18 dB	≥ 4.0 dB
+/- 9.0/10.5/ 6.0 MHz	≥ 40 dB	≥ 43 dB	≥ 18 dB
+/- 12.0/12.0/12.0 MHz	≥ 58 dB	≥ 55 dB	≥ 44 dB
Group Delay Variation	< 400 nS	< 350 nS	< 350 nS
VSWR/RL	1.12:1/24.9 dB (+/-2.86 MHz)	1.12:1/24.9 dB (+/-3.40 MHz)	1.12:1/24.9 dB (+/-3.90 MHz)
Ambient Temperature	0°C to 45°C (32°F to 113°F)		
Storage Temperature	-10°C to 55°C (14°F to 131°F)		
Connectors In/Out	1 5/8 EIA		
Humidity	<95% Non-Condensing		
Altitude	3048 m (10000')		
Dimensions (LxWxH)	597 mm X 381 mm X 178 mm (23.25" X 15" X 7")		
Weight	20.5 kg / 45 lb		
No Sections	6		
Transmission Zeros	4		

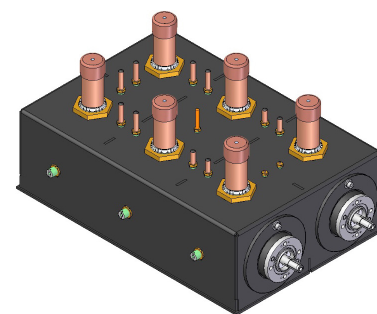

Dielectric POWERLITE™ Series 3kW Tunable Bandpass Filter

- For indoor applications
- For 6 MHz channel bandwidths in analog TV, digital TV and mobile media applications
- ATSC full mask, ATSC stringent mask, and ISDB-T non-critical mask
- Temperature compensated

Specifications

Model Number	UT6E7F-3K		
Mask	ATSC Full Mask	ATSC Stringent Mask	ISDB-T Non-Critical Mask
Maximum Input Power	3000 Watts		
Frequency	470-806 MHz		
Channel BW	6 MHz		
Insertion Loss			
Band Center	0.6 dB	0.6 dB	0.6 dB
Band Edge	1.1 dB (+/-2.69 MHz)	1.1 dB (+/-2.69 MHz)	1.1 dB (+/-2.79 MHz)
Attenuation			
+/- 3.50 MHz	≥ 1.5 dB	≥ 5 dB	NA
+/- 4.50 MHz	≥ 14 dB	≥ 23 dB	≥ 19 dB
+/- 6.0 MHz	≥ 33 dB	≥ 33 dB	NA
+/- 9.0 MHz	≥ 64 dB	NA	≥ 53 dB
Group Delay Variation	< 150 nS	< 200 nS	< 200 nS
VSWR/RL	1.12:1/24.9 dB (+/-2.69MHz)	1.12:1/24.9 dB (+/-2.69MHz)	1.12:1/24.9 dB (+/-2.79MHz)
Ambient Temperature	0°C to 45°C (32°F to 113°F)		
Storage Temperature	-10°C to 55°C (14°F to 131°F)		
Connectors In/Out	1 5/8 EIA		
Humidity	<95% Non-Condensing		
Altitude	3048 m (10000')		
Dimensions (LxWxH)	597 mm X 381 mm X 178 mm (23.25" X 15" X 7")		
Weight	20.5 kg / 45 lb		
No Sections	6		
Transmission Zeros	2		

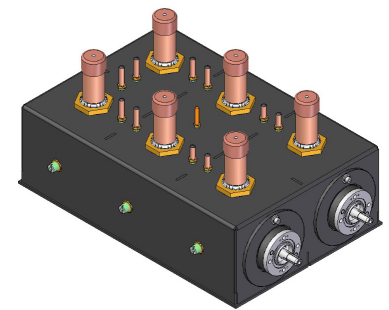

Dielectric POWERLITE™ Series 3kW Tunable Bandpass Filter

- For indoor applications
- Temperature compensated
- For 6, 7 and 8 MHz channel bandwidths in analog TV, digital TV and mobile media applications
- DVB-T critical mask

Specifications

Model Number	UT8D7F-3K		
Mask	DVB-T Critical	DVB-T Critical	DVB-T2/EXT Critical
Maximum Input Power	3000 Watts		
Frequency	470-862 MHz		
Channel BW	6 MHz	7 MHz	8 MHz
Insertion Loss			
Band Center	0.8 dB	0.7 dB	0.7 dB
Band Edge	2.4 dB (+/-2.86 MHz)	2.0 dB (+/-3.40 MHz)	1.6 dB (+/-3.80 MHz) 2.0 dB (+/-3.90 MHz) Ext.
Attenuation			
+/- 3.20/3.70/NA MHz	≥ 15 dB	≥ 15 dB	NA
+/- 4.50/5.25/4.20 MHz	≥ 28 dB	≥ 28 dB	≥ 15 dB
+/- 9.0/10.5/ 6.0 MHz	≥ 55 dB	≥ 53 dB	≥ 28 dB
+/- 12.0/12.0/12.0 MHz	≥ 60 dB	≥ 60 dB	≥ 55 dB
Group Delay Variation	<700 nS	< 700 nS	< 700 nS
VSWR/RL	1.12:1/24.9 dB (+/-2.86 MHz)	1.12:1/24.9 dB (+/-3.40 MHz)	1.12:1/24.9 dB (+/-3.90 MHz)
Ambient Temperature	0°C to 45°C (32°F to 113°F)		
Storage Temperature	-10°C to 55°C (14°F to 131°F)		
Connectors In/Out	1 5/8 EIA		
Humidity	<95% Non-Condensing		
Altitude	3048 m (10000')		
Dimensions (LxWxH)	770 mm X 381 mm X 178 mm (30.25" X 15" X 7")		
Weight	26.5 kg / 60 lb		
No Sections	8		
Transmission Zeros	4		

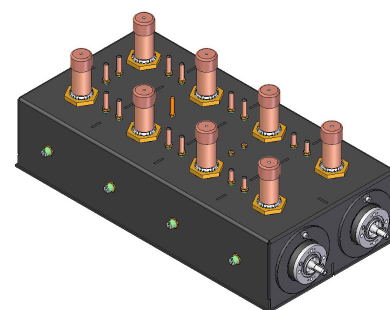

Dielectric POWERLITE™ Series 6kW Tunable Bandpass Filter

Liquid Cooled

- For indoor applications
- Temperature compensated
- For 6, 7 and 8 MHz channel bandwidths in analog TV, digital TV and mobile media applications
- DVB-T critical mask

Specifications

Model Number	UT8D7F-6K		
Mask	DVB-T Critical	DVB-T Critical	DVB-T2/EXT Critical
Maximum Input Power	6000 Watts		
Frequency	470-862 MHz		
Channel BW	6 MHz	7 MHz	8 MHz
Insertion Loss			
Band Center	0.8 dB	0.7 dB	0.7 dB
Band Edge	2.4 dB (+/-2.86 MHz)	2.0 dB (+/-3.40 MHz)	1.6 dB (+/-3.80 MHz) 2.0 dB (+/-3.90 MHz) Ext.
Attenuation			
+/- 3.20/3.70/NA MHz	≥ 15 dB	≥ 15 dB	NA
+/- 4.50/5.25/4.20 MHz	≥ 28 dB	≥ 28 dB	≥ 15 dB
+/- 9.0/10.5/ 6.0 MHz	≥ 55 dB	≥ 53 dB	≥ 28 dB
+/- 12.0/12.0/12.0 MHz	≥ 60 dB	≥ 60 dB	≥ 55 dB
Group Delay Variation	<700 nS	< 700 nS	< 700 nS
VSWR/RL	1.12:1/24.9 dB (+/-2.86 MHz)	1.12:1/24.9 dB (+/-3.40 MHz)	1.12:1/24.9 dB (+/-3.90 MHz)
Ambient Temperature	0°C to 45°C (32°F to 113°F)		
Storage Temperature	-10°C to 55°C (14°F to 131°F)		
Connectors In/Out	3 1/8 EIA		
Humidity	<95% Non-Condensing		
Altitude	3048 m (10000')		
Dimensions (LxWxH)	770 mm X 381 mm X 178 mm (30.25" X 15" X 7")		
Weight	33 kg / 70 lb		
No Sections	8		
Transmission Zeros	4		

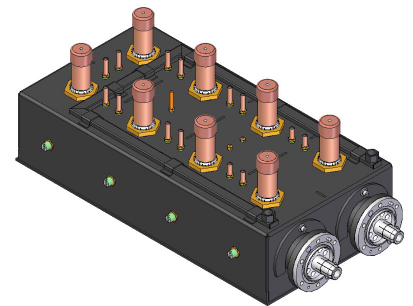

Dielectric POWERLITE™ Series 7kW Tunable Bandpass Filter

Liquid Cooled

- For indoor applications
- Temperature compensated
- For 6, 7 and 8 MHz channel bandwidths in analog TV, digital TV and mobile media applications
- DVB-T non-critical mask

Specifications

Model Number	UT6D7F-7K		
Mask	DVB-T Non-Critical	DVB-T Non-Critical	DVB-T2/EXT Non-Critical
Maximum Input Power	6500 Watts		
Frequency	470-862 MHz		
Channel BW	6 MHz	7 MHz	8 MHz
Insertion Loss			
Band Center	0.6 dB	0.5 dB	0.5 dB
Band Edge	1.1 dB (+/-2.86 MHz)	1.0 dB (+/-3.40 MHz)	1.0 dB (+/-3.80 MHz) 1.1 dB (+/-3.90 MHz) Ext.
Attenuation			
+/- 3.20/3.70/NA MHz	≥ 3.0 dB	≥ 3.5 dB	NA
+/- 4.50/5.25/4.20 MHz	≥ 18 dB	≥ 18 dB	≥ 4.0 dB
+/- 9.0/10.5/ 6.0 MHz	≥ 40 dB	≥ 43 dB	≥ 18 dB
+/- 12.0/12.0/12.0 MHz	≥ 55 dB	≥ 55 dB	≥ 44 dB
Group Delay Variation	< 400 nS	< 350 nS	< 350 nS
VSWR/RL	1.12:1/24.9 dB (+/-2.86 MHz)	1.12:1/24.9 dB (+/-3.40 MHz)	1.12:1/24.9 dB (+/-3.90 MHz)
Ambient Temperature	0°C to 45°C (32°F to 113°F)		
Storage Temperature	-10°C to 55°C (14°F to 131°F)		
Connectors In/Out	3 1/8 EIA		
Humidity	<95% Non-Condensing		
Altitude	3048 m (10000')		
Dimensions (LxWxH)	597 mm X 381 mm X 178 mm (23.25" X 15" X 7")		
Weight	26.5 kg / 60 lb		
No Sections	6		
Transmission Zeros	4		

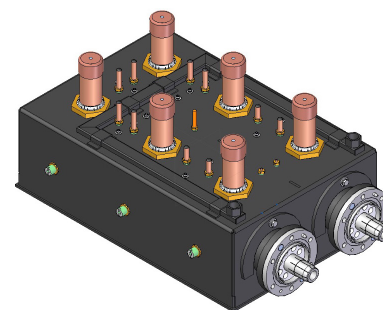

Dielectric POWERLITE™ Series 7kW Tunable Bandpass Filter

Liquid Cooled

- For indoor applications
- For 6 MHz channel bandwidths in analog TV, digital TV and mobile media applications
- ATSC full mask, ATSC stringent mask, and ISDB-T non-critical mask
- Temperature compensated

Specifications

Model Number	UT6E7F-7K		
Mask	ATSC Full Mask	ATSC Stringent Mask	ISDB-T Non-Critical Mask
Maximum Input Power	6000 Watts		
Frequency	470-806 MHz		
Channel BW	6 MHz		
Insertion Loss			
Band Center	0.6 dB	0.6 dB	0.6 dB
Band Edge	1.1 dB (+/-2.69 MHz)	1.1 dB (+/-2.69 MHz)	1.1 dB (+/-2.79 MHz)
Attenuation			
+/- 3.50 MHz	≥ 1.5 dB	≥ 5 dB	NA
+/- 4.50 MHz	≥ 14 dB	≥ 23 dB	≥ 19 dB
+/- 6.0 MHz	≥ 33 dB	≥ 33 dB	NA
+/- 9.0 MHz	≥ 64 dB	NA	≥ 53 dB
Group Delay Variation	< 150 nS	< 200 nS	< 200 nS
VSWR/RL	1.12:1/24.9 dB (+/-2.69MHz)	1.12:1/24.9 dB (+/-2.69MHz)	1.12:1/24.9 dB (+/-2.79MHz)
Ambient Temperature	0°C to 45°C (32°F to 113°F)		
Storage Temperature	-10°C to 55°C (14°F to 131°F)		
Connectors In/Out	3 1/8 EIA		
Humidity	<95% Non-Condensing		
Altitude	3048 m (10000')		
Dimensions (LxWxH)	597 mm X 381 mm X 178 mm (23.25" X 15" X 7")		
Weight	26.5 kg / 60 lb		
No Sections	6		
Transmission Zeros	2		

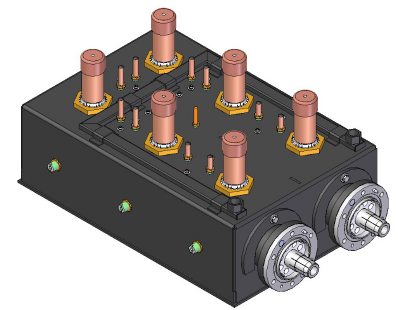

6 Pole Filter Standard Masks

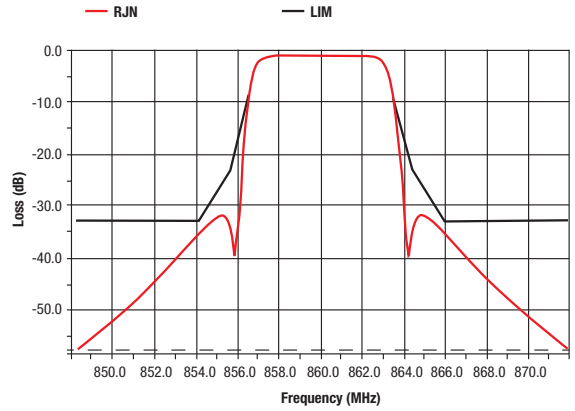
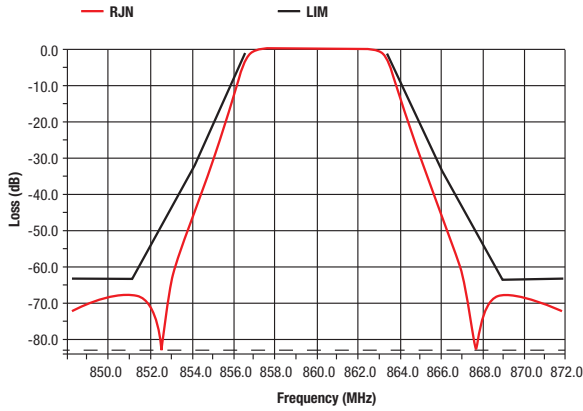

ATSC Full Mask

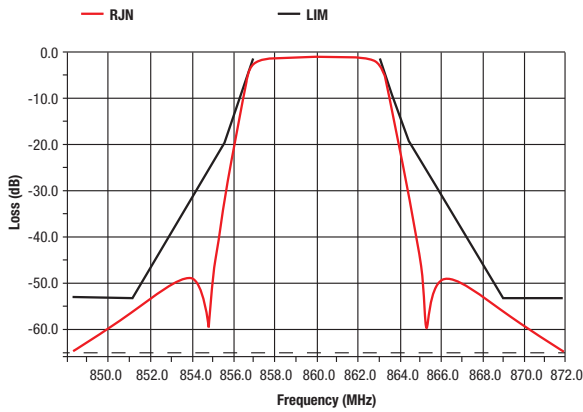

ATSC Stringent Mask

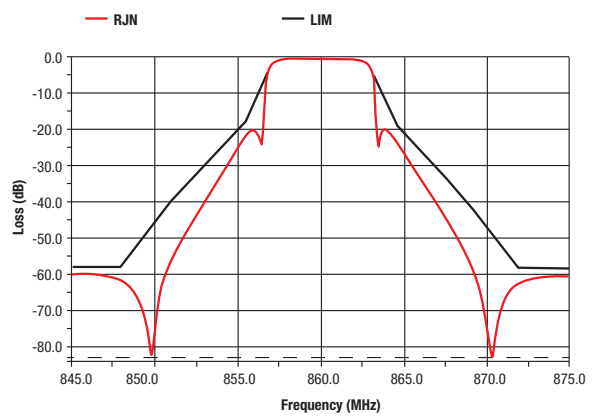

ISDB-T Non-Critical Mask

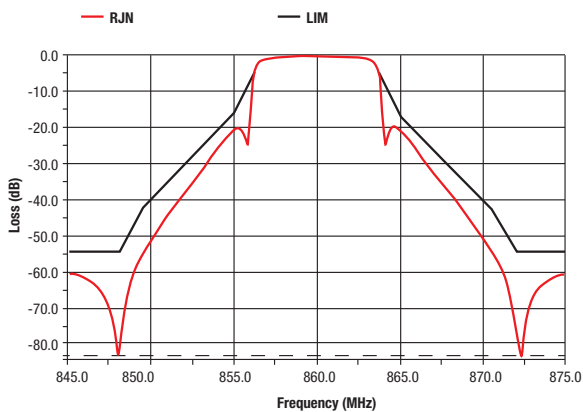

6 MHz DVB-T Non-Critical Mask

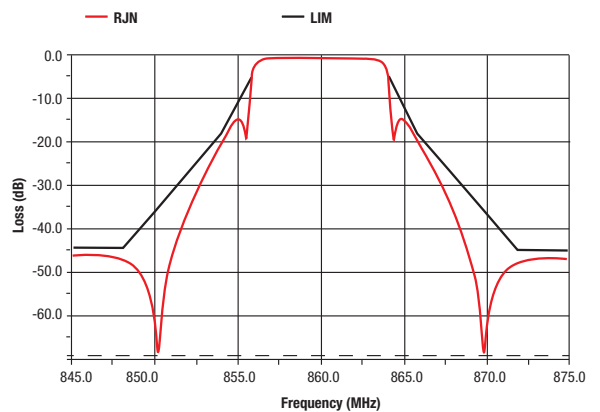

7 MHz DVB-T Non-Critical Mask

8 MHz DVB-T Non-Critical Mask

8 Pole Filter Standard Masks

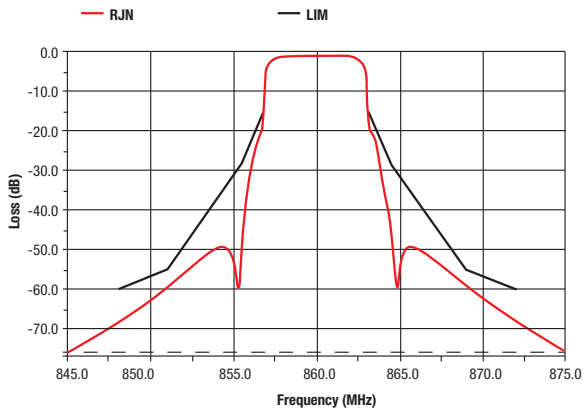

6 MHz DVB-T Critical Mask

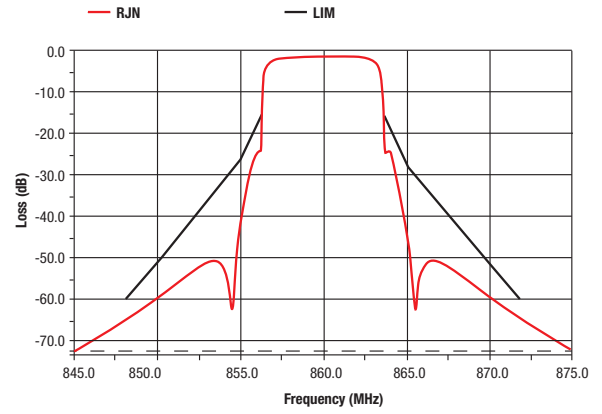

7 MHz DVB-T Critical Mask

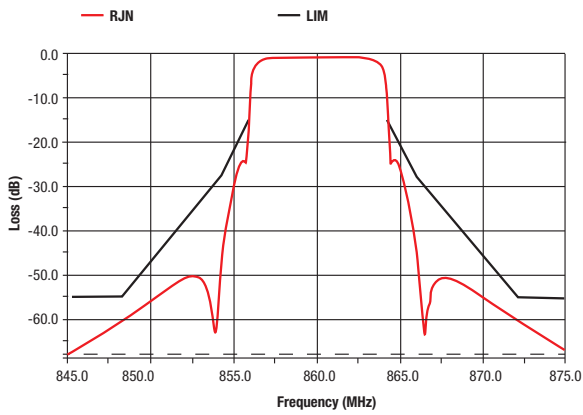

8 MHz DVB-T Critical Mask

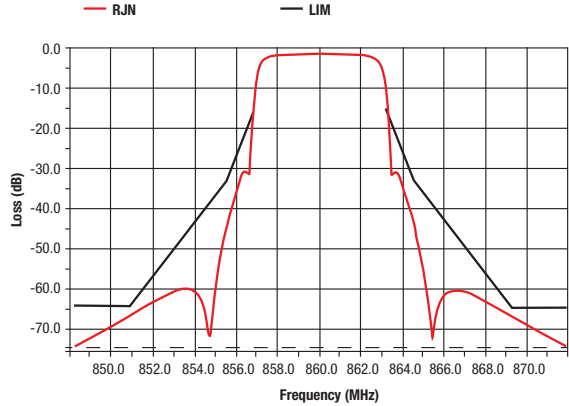

ISDB-T Critical Mask

Dielectric products are represented in 90 countries around the world.

With the rapid expansion of communications, Dielectric is positioned to service the broadcast needs of small and large stations, DTV and NTSC, FM and specialty RF systems, complete systems and components.



Abu Dhabi
Angola
Argentina
Australia
Austria
Belgium
Belize
Benin
Botswana
Brazil
Canada
Chad
Chile
China
Colombia
Costa Rica
Denmark
Dominican Republic
Ecuador
Egypt
El Salvador
England
Ethiopia
Finland
France
Germany
Ghana
Greece
Greenland
Guam

Guatemala
Hong Kong
Iceland
India
Indonesia
Ireland
Israel
Italy
Japan
Jordan
Korea
Kuwait
Lebanon
Liberia
Madagascar
Malaysia
Mali
Malta
Mauritania
Mauritius
Mexico
Mongolia
Morocco
Nepal
Netherlands
New Zealand
Nicaragua
Nigeria
Norway
Oman

Pakistan
Papua New Guinea
Peru
Philippines
Poland
Portugal
Puerto Rico
Qatar
Romania
Russia
Saipan
Sao Tome
Saudi Arabia
Singapore
South Africa
Spain
Sri Lanka
Sweden
Switzerland
Syria
Taiwan
Thailand
Togo
Uganda
United States
Venezuela
Vietnam
Yemen
Zambia
Zimbabwe