

Anchor connector (inner-conductor connector and insulator).

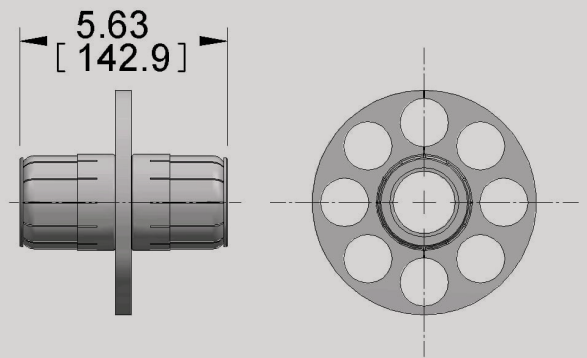

T/L SIZE

**Catalog
Number**

**Impedance in
Ohms**

Length 1

Length 2 Ref.

Approx. Wt.

6 1/8"

677-011

75

2 3/8"

5 3/8"

2 lbs

Trusted for Decades. Ready for Tomorrow.