

digitLine

Transmission line with flanges on both ends. Includes expansion connector, O-ring, and hardware kit.

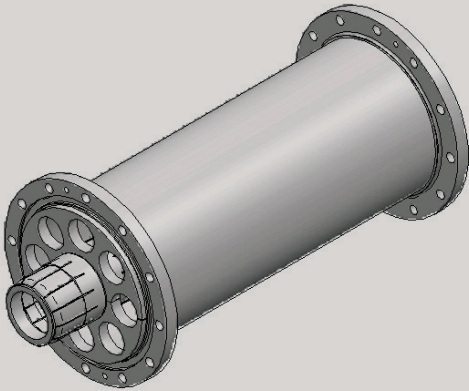

Technical Images

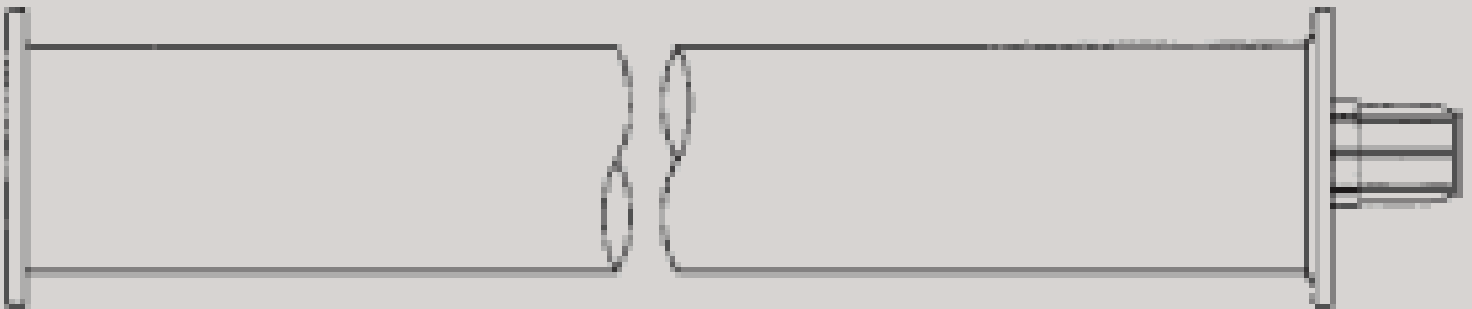

Specifications

Type	T/L Size	Catalog #	Impedance in Ohms	L1	L2	Approx. Wt.
Transmission Line	6 1/8"	DL 67-004	75	N/A	N/A	145 lbs