

90° reinforced elbow, one long and one short leg. Includes one anchor connector, one O-ring and one hardware kit. Swivel flanges.

45° elbow, one long and one short leg. Includes one anchor connector, one O-ring and one hardware kit. Swivel flanges.

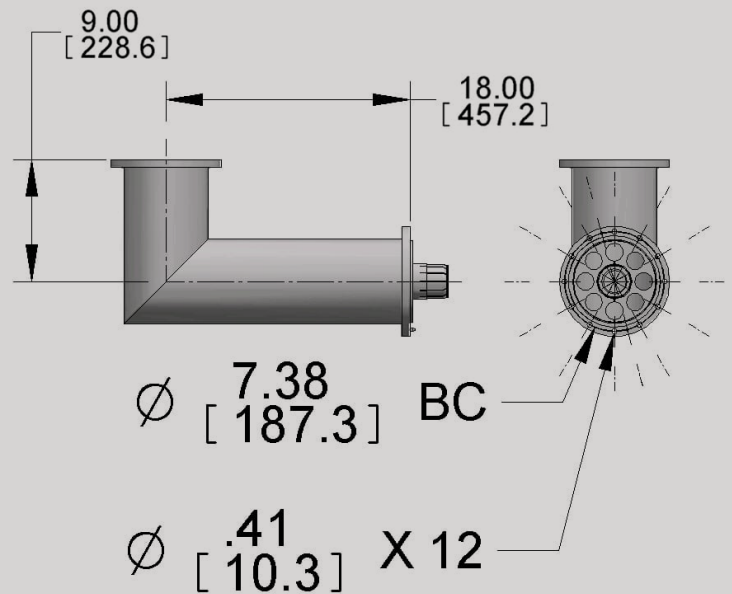
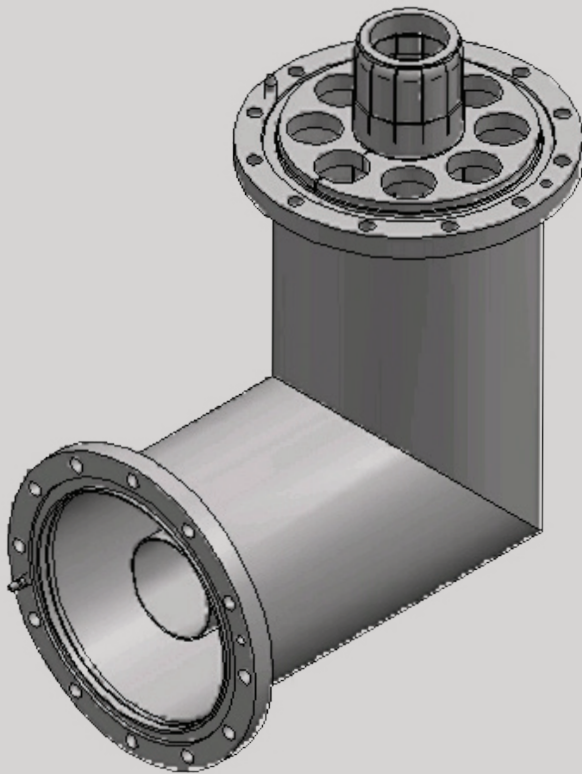

Trusted for Decades. Ready for Tomorrow.

90° Elbow (Unequal Leg)

T/L SIZE	Catalog Number	Impedance in Ohms	L1	L2	Approx. Wt.
3 1/8"	375-018	50	6"	9"	12 lbs

90° Mitre Elbows (Unequal Leg) Reinforced

T/L SIZE	Catalog Number	Impedance in Ohms	L1	L2	Approx. Wt.
3 1/8"	375-022	50	6"	9"	13 lbs

45° Mitre Elbows (Unequal Leg)

T/L SIZE	Catalog Number	Impedance in Ohms	L1	L2	Approx. Wt.
3 1/8"	375-020	50	6"	12"	12 lbs

90° Mitre Elbows (Equal Leg)

T/L SIZE	Catalog Number	Impedance in Ohms	L	Approx. Wt.
3 1/8"	375-017	50	6"	9 lbs

90° Mitre Elbows (Equal Leg) Reinforced

T/L SIZE	Catalog Number	Impedance in Ohms	L	Approx. Wt.
3 1/8"	375-021	50	6"	14 lbs