

Transmission line with flanges on both ends. Includes one anchor connector, one O-ring and one hardware kit.

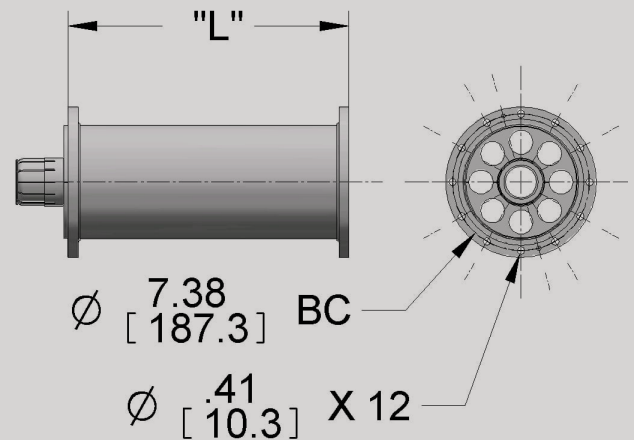

With Expansion Inner Conductor

T/L SIZE	Catalog Number	Impedance in Ohms	L	Approx. Wt.
3 1/8"	375-004	50	20'	56 lbs
3 1/8"	375-003	50	19.5'	51 lbs

Without Expansion Compensation

T/L SIZE	Catalog Number	Impedance in Ohms	L	Approx. Wt.
3 1/8"	375-002	50	20'	60 lbs
3 1/8"	375-001	50	19.5'	56 lbs

Trusted for Decades. Ready for Tomorrow.