

90° reinforced elbow, one long and one short leg. Includes one anchor connector, one O-ring and one hardware kit. Swivel flanges.

45° elbow, one long and one short leg. Includes one anchor connector, one O-ring and one hardware kit. Swivel flanges.

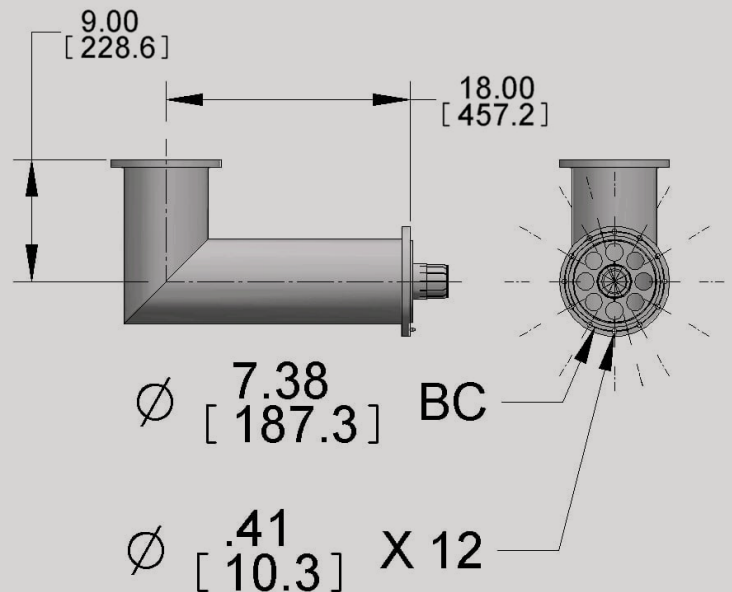
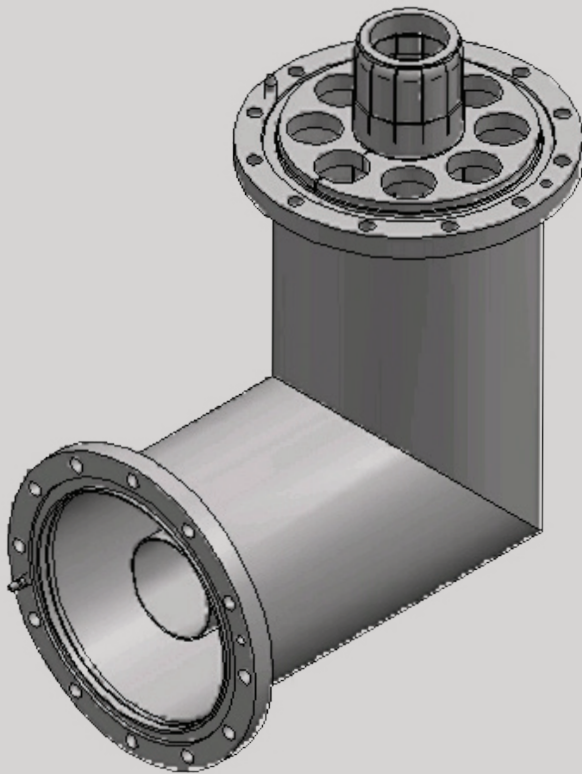

Trusted for Decades. Ready for Tomorrow.

90° Elbow (Unequal Leg)

T/L SIZE	Catalog Number	Impedance in Ohms	L1	L2	Approx. Wt.
6 1/8"	675-018	50	9"	18"	31 lbs

90° Mitre Elbows (Unequal Leg) Reinforced

T/L SIZE	Catalog Number	Impedance in Ohms	L1	L2	Approx. Wt.
6 1/8"	675-022	50	9"	18"	32 lbs

45° Mitre Elbows (Unequal Leg)

T/L SIZE	Catalog Number	Impedance in Ohms	L1	L2	Approx. Wt.
6 1/8"	675-020	50	9"	12"	31 lbs

90° Mitre Elbows (Equal Leg)

T/L SIZE	Catalog Number	Impedance in Ohms	L	Approx. Wt.
6 1/8"	675-017	50	9"	28 lbs

90° Mitre Elbows (Equal Leg) Reinforced

T/L SIZE	Catalog Number	Impedance in Ohms	L	Approx. Wt.
6 1/8"	675-021	50	9"	29 lbs